

HEB

WEATHERPROOF CAMERA HOUSING

MAIN FEATURES

IP66/IP67 (with cable glands or optional sealing rings)

Slide extractable body with hinged system

Pre-arranged for internal cable management bracket

Available accessories: heater, camera power supply, blower and air filter

DESCRIPTION

Robust and large aluminum housing designed to fit combinations of 1/2", 1/3" and 1/4" cameras and with optics of different kinds.

The frontal opening system allows an easy access to the camera and all internal connections.

A wide range of accessories for mounting the equipment is available thereby satisfying all installation needs.



HEB



HEB + WBOVA2

AVAILABLE MODELS

Model Number	Sunshield	Heater 120/230Vac	Heater 12Vdc/24Vac	Max consumption
HEB26D0A000B	–	–	–	–
HEB26K0A000B	✓	–	–	–
HEB26K1A000B	✓	✓	–	40W
HEB26K2A000B	✓	–	✓	20W
HEB32D0A000B	–	–	–	–
HEB32K0A000B	✓	–	–	–
HEB32K1A000B	✓	✓	–	40W
HEB32K2A000B	✓	–	✓	20W

TECHNICAL DATA

GENERAL

Aluminium back and front cover plates
 Extruded aluminium body, external slide and sunshield
 Epoxypolyester powder painting, RAL9002 colour
 Stainless steel external screws

MECHANICAL

Cable glands: 3xM16
 Glass window (WxH): 90x81mm (3.5x3.2in)
 Internal usable area (WxH): 90x85mm (3.5x3.3in)
 Internal usable length (without accessories):
 HEB26 260mm (10.2in)
 HEB32 320mm (12.6in)
 Internal usable length (with accessories):
 HEB26 190mm (7.5in)
 HEB32 250mm (9.8in)
 Unit weight: 2.7kg-6lb (HEB26), 3.2kg-7.1lb (HEB32)

ELECTRICAL

Heater (Ton 15°C±3°C (59°F ±5°F), Toff 22°C±3°C (77°F±5°F))

- Power supply/Consumption: IN 12Vdc/24Vac, 20W max
- Power supply/Consumption: IN 120/230Vac, 40W max

Blower with thermostat and air filter, Ton 35°C±3°C (95°F±5°F) Toff 20°C±3°C (71°F±5°F) and back cover

- IN 12Vdc, consumption 4W max
- IN 24Vac, consumption 4W max
- IN 230Vac, consumption 4W max, complete with voltage transformer

Not compatible with bracket with internal cable channel.
 Camera power supply

- IN 100-240Vac, 50/60Hz - OUT 12Vdc, 1A
- IN 230Vac - OUT 24Vac, 50/60Hz, 400mA

ENVIRONMENT

Indoor/Outdoor
 Operating temperature with heater: -20°C / +60°C (-4°F / +140°F)
 Resistant to salty fog until 1000 hours (according to ISO9227)

CERTIFICATIONS

CE EN61000-6-3, EN60065, EN50130-4
 IP66/IP67 EN60529 with cable glands
 IP66/IP67 EN60529 with special gaskets and bracket with internal cable channel
 IP55 EN60529 with bracket with internal cable channel

ACCESSORIES

OHEH01B	Heater 12Vdc/24Vac for HEB, HEK housings
OHEH02B	Heater 120/230Vac for HEB, HEK housings
OHEBVF1	Blower with thermostat and air filter IN 12Vdc, for HEB housing, not compatible with WBOVA2 and WBOV3A2 brackets
OHEBVF2	Blower with thermostat and air filter IN 24Vac, for HEB housing, not compatible with WBOVA2 and WBOV3A2 brackets
OHEBVF3	Blower with thermostat and air filter IN 230Vac, for HEB housing, not compatible with WBOVA2 and WBOV3A2 brackets
OHEPS01B	Wide range camera power supply IN 100-240Vac - OUT 12Vdc, 15W, for HEB housing
OHEPS02B	Camera power supply IN 230Vac - OUT 24Vac, 10VA, for HEB housing
OWBIP2	Sealing rings kit (3xM16) IP66/IP67 for WBOVA2 and WCM4A2 brackets for PUNTO, HOV, HTV, HTC, VERSO, VERSO POLAR, VERSO COMPACT, HEB, HEK housings
OHEGBB	Weatherproof junction box

RELATED PRODUCTS

PTH300	Horizontal/vertical Pan & Tilt
PTH900	Horizontal/vertical Pan & Tilt

BRACKETS AND ADAPTORS

WBJA	Ceiling bracket with ball joint
WBMA	Wall bracket with ball joint
WBOVA2	Wall bracket with internal cable channel
WBOV3A2	Wall bracket with internal cable channel, counterplate and support box, not compatible with OHEBVF1, OHEBVF2 and OHEBVF3
WCM3A	Ceiling bracket with ball joint
WCM5A	Ceiling bracket with ball joint
WCM4A2	Ceiling bracket with internal cable channel
WFWCA	Column bracket with joint

SPARE PARTS

OHEBS26A000	Sunshield HEB26
OHEBS32A000	Sunshield HEB32
DOTHE01	Spacers for camera and lens
OHEBMAN	Cable glands, gaskets and screws
OHBCFA04	Front cover with glass, screws and gaskets
OHBFPO4B	Back cover with cable glands, gaskets and screws

PACKAGE

Model Number	Weight	Dimensions (WxHxL)	Master carton
HEB26K1A000B	3kg (6.6lb)	15.5x14x43cm (6.1x5.5x17)	10
HEB32K1A000B	3.5kg (7.7lb)	16.5x15.5x49cm (6.5x6.1x19.3in)	10

TECHNICAL DRAWINGS

Sizes in millimeters.

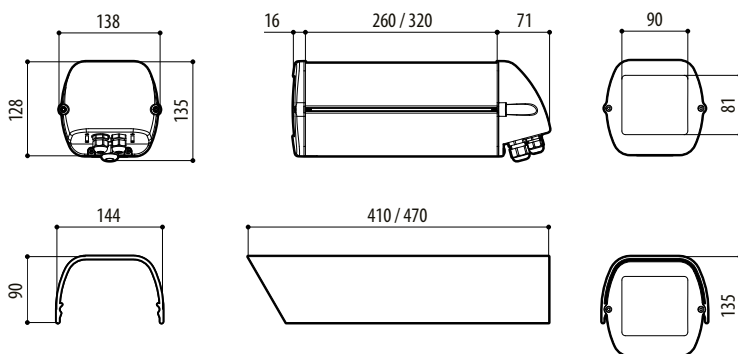

HEB