

V661V SERIES VANDALPROOF ANALOG CAMERA DOME



Product at a Glance

- ▶ Day/Night and IR illumination models available
- ▶ On-screen menus with innovative joystick control make setup and operation easy
- ▶ Privacy masking
- ▶ 700 TV lines (750 in IR model)
- ▶ 3D Digital Noise Reduction (IR model)
- ▶ HLC (High Light Compensation)
- ▶ Wall or ceiling mounting
- ▶ Easy to install and set up
- ▶ IP66 rated

The V661V-1 Series of Outdoor Camera Domes offers a compact, vandalproof domed housing incorporating a fixed camera and lens combination. They are configured for wall or ceiling mounting. Day/Night and Infrared Illumination (IR) models are offered in NTSC and PAL versions.

Camera and Optics Provide Outstanding Performance and Value

The V661V-1 Series includes a 2.8-12 mm varifocal lens that provides superb sharpness and excellent sensitivity. The cameras utilize a 1/3-inch CCD device with a resolution of 700 TV lines or 750 TV lines in IR model.

The IR camera provides advanced 3D digital noise reduction, which significantly reduces motion blur during low light conditions and greatly reduces video noise. This improves image quality, minimizes video interference and triggering of false alarms and provides a better compression ratio, which decreases storage requirements. The day/night camera provides 2D DNR with an ICR filter for excellent performance in low-light conditions.

The cameras provide motion detection, backlight compensation, highlight compensation and automatic white balance. Digital image stabilization (IR model) provides a stable image in a variety of conditions for excellent recording and playback.

Durable Construction and Easy Installation

The cameras are constructed of die-cast aluminum with a high-impact polycarbonate plastic dome. Tamper-resistant screws make the unit resistant to vandalism. The IP66 rated camera package is designed to withstand the harshest conditions and destructive environments of correctional facilities, warehouses and loading docks. The cameras may be wall or ceiling mounted. Optional accessories are available for pole, corner, in-ceiling and pendant-style mounting. An optional heater accessory extends the low temperature range of the units.

The extensive on-screen display menus allow for set up of white balance, AGC, backlight compensation, exposure, titling, privacy masks and many other functions.

The camera position is adjustable, allowing for adjustment of pan (360°), tilt (90° from vertical) and rotation about its axis (roll/azimuth), for any angle of view required. The lens zoom and focus can be easily adjusted.

SPECIFICATIONS

Camera and Optics

	Model Numbers	
	V661V-312IR-1	V661V-312N-1
Type:	IR*	Day/Night
Image Device:	1/3-inch Sony Super HAD II CCD	1/3-inch CCD
Picture Elements:	NTSC: 976 (H) x 494 (V), 482,000 pixels PAL: 976 (H) x 582 (V), 568,000 pixels	
Scanning System:	2:1 interlace	
Synchronization:	Internal/ Line Lock	Internal
Shutter Speed:	NTSC: 1/60-1/100,000 sec/PAL: 1/50-1/100,000 sec	
Horizontal Resolution:	750 TV lines color	700 TV lines color
Sensitivity:	Color: 0.1 lux B&W: 0.01 lux Slow Shutter: 0.001 lux with f/1.2 lens at 50 IRE	Color: 0.1 lux B&W: 0.04 lux with f/1.2 lens at 50 IRE
Video Output:	1.0 V p-p @75 ohms, composite	
S/N Ratio:	>50 dB (AGC off)	>50 dB (AGC off)
Camera Control:	Joystick OSD Control; coaxial COMM (32-bit); RS-485 (Pelco D)	Joystick OSD Control
Auto Iris Control:	DC/Manual	DC/Manual
Brightness:	0-255	
Backlight Compensation:	Off/BLC/HLC	
Automatic Gain Control (AGC):	6 - 44.8 DB	Selectable: Off, Low, Middle, High
Wide Dynamic Range:	D-WDR Selectable: Off/ATR-EX Low, Middle, High	D-WDR (On/Off)
Sense Up:	Off/Auto (X256)	N/A
Digital Noise Reduction:	2 DNR/3D DNR; gain adjust	2D DNR; On/Off
Image Stabilization:	On/Off (Digital Image Stabilization)	N/A
White Balance:	User 1/User 2/ATW/Manual/Push/Push Lock	ATW1/ATW2/AWC-Set/Anti Color Rolling/Manual
Privacy Mask:	On/Off; 15 programmable zones (polygonal mosaic); choice of colors	On/Off; 8 programmable zones; choice of colors
Motion Detection:	Off/On; 4 areas: defined sensitivity, size, mask area	
Lens Shading Compensation:	Lens Shading On/Off	Lens Shading On/Off (0-255)
Dead (White) Pixel Compensation:	White: Auto /Manual (64 point)	Dead: Auto
Day/Night:	Auto, Color, B&W	Burst: On/Off IR Smart: On/Off IR Level: On/Off
Digital Zoom:	Off/0-X255 E-zoom; digital pan/tilt	N/A
Digital Effects:	Vertical Flip/Mirror/Rotation/Negative-Positive/ Freeze/ Sharpness	Mirror/Neg or Pos/Sharpness/Contrast/Parking Line
Defog:	Auto	N/A

* IR model features IR illumination (30 LEDs) for use in no-light environments. Illuminated distance up to 98.4 feet (30 m).

SPECIFICATIONS

Lens:

Focal Length:	2.8-12 mm	2.8-12 mm
Aperture:	f/1.4	f/1.4
Field of View:	2.8 mm: 94.2° H 12 mm: 26.2° H	2.8 mm: 94.2° H; 12 mm: 26.2° H

Electrical

	Model Numbers	
	V661V-312IR-1	V661V-312N-1
Input Voltage:	12 VDC ±10% or 24 VAC ±10%	
Current:	180 mA	200 mA
Power Consumption:	2.2 W maximum	2.5 W maximum
Connectors:	Power: 2-pin connector Video: BNC on pendant cable RS-485: 2-pin connector Alarm Out: Fixed Lens Mount	Power: 2-pin connector Video: BNC on pendant cable Fixed Lens Mount
Certifications:	UL, CE, FCC, Class A, IP66	
Warranty:	3 years parts and labor	

Operational

Control Display:	On-screen, menu-driven system allowing full configuration of the camera
Tilt and Horizontal Adjustment:	Pan, 360°; tilt, 90° from vertical and rotation about its axis (roll/azimuth)
Lens Adjustment:	Focus: focus lever screw Zoom: zoom lever screw
Titling:	On/Off, alphanumeric character set

Environmental

Operating Temperature Range:	14 to 122° F (-10 to 50° C)
Operating Humidity Range:	Up to 90% relative, non-condensing

Warranty

3 years parts and labor

Ordering Information

Description	Model Number
IR Vandal-Proof dome camera. 1/3-inch format with DNR and 750 TV line resolution. 12 VDC or 24 VAC.	V661V-312IR-1
Day/Night Vandal-Proof dome camera. 2.8-12 mm lens, 1/3-inch format with DNR and 700 TV line resolution. 12 VDC or 24 VAC.	V661V-312N-1

For PAL models add a -P to the Model Number. For example: V661V-312IR-1-P.





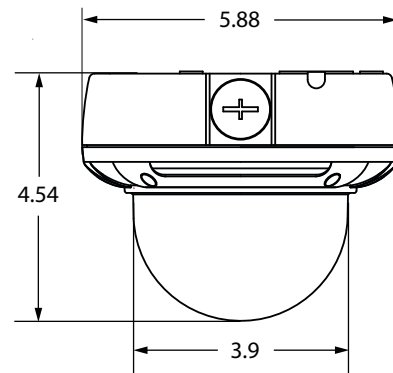

SPECIFICATIONS

- ▶ Die-cast aluminum construction with polycarbonate plastic dome and black mask. Rated for IP66 ingress protection
- ▶ Wall or ceiling mounting

- ▶ Housing Diameter: 5.75 inches (146 mm)
- ▶ Dome Diameter: 3.8 inches (99 mm)
- ▶ Height: 4.54 inches (115.4 mm)
- ▶ Weight: 1.54 lb. (0.7 kg)



Mounting Accessories

	Description	Model Number
	In-ceiling mount kit for vandal-proof domes.	V660-HCS254
	Wall-mount arm for camera domes.	V660-HDB243
	Wall/Ceiling mount kit for vandal-proof domes	V660-HVPWCB2
	Corner-mount adapter for vandal-proof domes. Used with V660-HVPWCB2.	V660-HCM150
	Pole-mount adapter for vandal-proof domes. Used with V660-HVPWCB2.	V660-HCM151
	NPT-pipe adapter for vandal-proof domes.	V660-HDA202
	Heater accessory for V660-Series indoor and outdoor camera domes.	V660-HT202VF
	Allows the camera dome to be mounted on a 4 x 4 electrical box with a neat look	V660-TRIM