

# SANYO

## Digital Video Recorder

### DSR-3000P 1-channel PAL

## Digital Transport Duplex Multiplexer

### MPX-CD163P 16-channel PAL

### MPX-CD93P 9-channel PAL

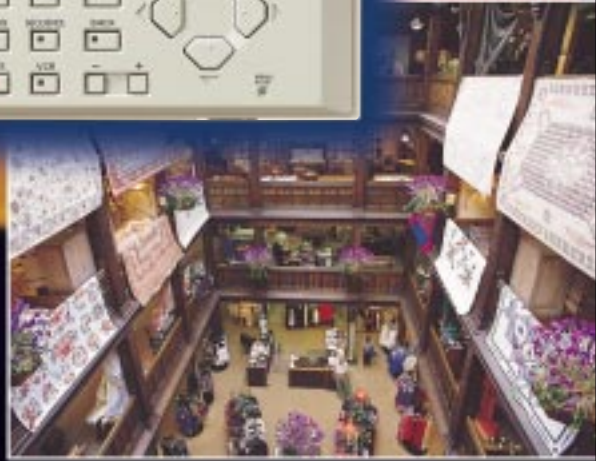

**50 fields/sec.**  
Simultaneous Recording and Playback

Horizontal  
**520**  
TV Lines

**Digital Connections**  
for System Expansion

**Coaxial Camera Control**





DSR-3000P front panel

## Digital Video Recorder

## DSR-3000P 1-channel PAL

Horizontal Resolution

# more than 520 TV Lines



**Digital**

**Analog**

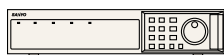

### DSR-3000P

Horizontal Resolution:  
More than 520 TV Lines



### Analog Time Lapse VCR

Horizontal Resolution:  
More than 250 TV Lines  
(standard model)

\* Photos used in the comparison are conceptual ones describing the effects of the technology (comparison based on SANYO products)

### Overall picture quality improvement achieved by digital processing

DSR-3000P uses motion JPEG compression, which has been proven to produce excellent images, in making digital recording and has achieved horizontal resolution of more than 520 TV lines as well as S/N ratio of 48 dB or better. A 200% improvement in picture quality is possible, compared to conventional analog time lapse VCR\*. The new processing method is also effective in resolving problems associated with analog recording, such as smudges, vertical drift, and jitters, and provides clear surveillance pictures. \* SANYO standard model

### Digital Transport Terminals (Digital-to-Digital)

DSR-3000P is equipped with Digital Video In / Out terminals to accommodate data transfer to and from the newly developed SANYO multiplexer MPX-CD163P or

MPX-CD93P without any conversion into an analog signal. The digital-to-digital connection is a key element in reducing video signal deterioration and achieving the amazingly high horizontal resolution of more than 520 TV lines.

Refer to the "System Example No.1 / No.2 / No.3" on page 4.

The unit also includes a JPEG encoder-decoder, which provides an interface with conventional composite video signals and the Y/C separate video signal.

### Simultaneous Recording and Playback at 50 fields/sec. (Full Movie)

SANYO's unique technology has made it possible to record and playback moving pictures simultaneously without any interruption at 50 fields/sec. This is useful for making a backup recording on another VCR, from the HDD, while continuing to record surveillance pictures.

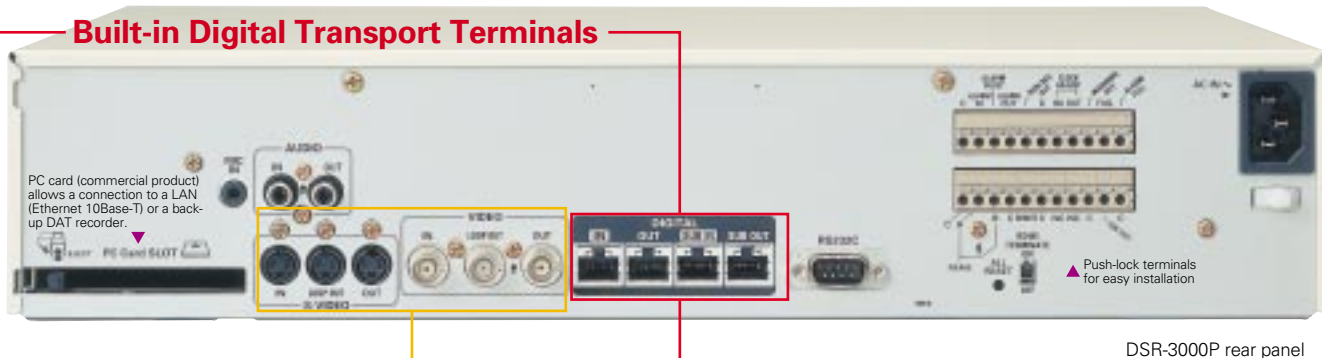

DSR-3000P rear panel

**Three Storage Areas**

There are three distinct storage areas — standard recording area, alarm area, and archive area. You can adjust the settings for the standard recording area and the alarm area.

**Built-in 80 GB HDD**

Picture quality: In basic mode, 4,600,000 fields can be recorded on the HDD, more than twice as many fields as a VHS tape (E-180). This is equivalent to approximately 77 hours of video recording with seamless motion at 0.06 sec. interval (16.67 fields/sec.).

You can also install one additional 80 GB hard disk drive (sold separately) in the HDD expansion bay.

**Mirror Recording**

By adding an optional HDD, it is possible to record the same video on two HDDs, thus allowing the user to use one of them as a backup. When mirroring is enabled, the recording speed is automatically limited to 0.12/sec maximum.

**Series Connection for up to 3 Units**

The Digital Video In / Out terminals allow up to three DSR-3000Ps in series, to increase the recording capacity to up to 480 GB.

Refer to the "System Example No.2" on page 4.

**Labor Saving**

The adoption of a hard disc drive as a recording medium eliminates the need to replace video tape, which is inevitable in conventional time lapse VCRs, since repeated recordings on a HDD have very little effect on the picture quality.

**Simultaneous Use with Three Recording Modes**

DSR-3000P has three recording modes: timer, pre-alarm, and post-alarm recording. The pre-alarm recording mode saves up to 15 minutes of video prior to an alarm input and is very useful for analyzing the situation. In the post-alarm recording mode, up to 15 minutes of recording after an alarm input is possible. All three recording mode can also be enabled simultaneously.

\* The built-in video sensor can only be enabled when one camera is connected.

**Built-in Video Sensor**

DSR-3000P includes a built-in video sensor. The sensor can detect moving objects within the screen by sensing brightness. This function can be used to trigger an alarm, pre-alarm recording, and post-alarm recording.

**Instant Search with Five Different Search Functions**

DSR-3000P features five different search functions — Day / time Search, Alarm Search, Alarm Thumbnail Search, Archive Area Search, and Motion Detection Search. Unlike a time lapse VCR, forwarding and rewinding tape is not necessary since recorded data is stored on a hard disc. It offers an instant search capability even though the data storage is huge.

Anticipating the availability of bigger HDDs, DSR-3000P is designed to accommodate a HDD of 130 GB maximum.

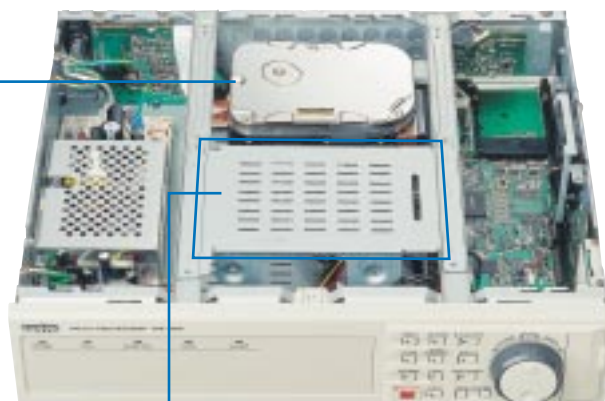

**HDD Expansion Bay**

An additional HDD may be installed within the unit. VA-HD3080, an optional 80 GB HDD, will be available soon.

**DSR-3000P Recording Time** HDD 80 GB, Field recording

Recording Speed fields/sec.	Recording Interval (sec.)	Picture Quality					Audio Recording
		Basic 15 kB	Normal 22 kB	Enhanced 30 kB	Fine 42 kB	Super Fine 56 kB	
Recording Time (unit: hour)							
50.00	0.02	25	18	13	9	7	Available
25.00	0.04	51	36	27	19	14	
16.67	0.06	76	54	40	29	22	
12.50	0.08	102	72	54	39	29	
8.33	0.12	153	108	81	59	44	
6.25	0.16	204	144	108	78	59	
5.00	0.20	255	180	135	98	74	
4.17	0.24	306	217	162	118	89	
3.57	0.28	357	253	189	138	104	
3.13	0.32	408	289	217	157	119	
2.78	0.36	459	325	244	177	134	Not available
2.50	0.40	510	361	271	197	149	
2.27	0.44	561	397	298	217	164	
1.92	0.52	663	470	352	256	194	
1.67	0.60	765	542	406	295	224	
1.47	0.68	868	614	461	335	254	
1.32	0.76	970	687	515	374	284	
1.19	0.84	1,072	759	569	414	314	
1.09	0.92	1,174	831	623	453	344	
1.00	1	1,276	904	678	493	374	
0.50	2	2,553	1,808	1,356	986	748	
0.33	3	3,829	2,712	2,034	1,479	1,122	
0.25	4	5,106	3,616	2,712	1,972	1,496	
0.20	5	6,382	4,521	3,390	2,466	1,870	
0.10	10	12,765	9,042	6,781	4,932	3,741	
0.05	20	25,531	18,084	13,563	9,864	7,483	
0.03	30	38,296	27,126	20,345	14,796	11,224	

In frame recording mode, the recording time will be half the time listed. Audio recording is also possible for the recording interval of 0.02 through 0.12 sec.

\* The recording time may vary slightly depending on the complexity of the images and the presence of an audio signal.  
 \* The table above lists the picture quality vs. recording time for a field recording using the standard recording area of the 80GB HDD, using the default settings. The recording time will change depending on the settings for the storage area, use of frame recording, and adding an optional HDD.

**Alarm Thumbnail Search**

It is possible to display up to nine thumbnails for video recordings in the alarm area along with their respective alarm numbers. This feature allows the user to search for a particular event without playing back each recording.

**Archive Search**

A list of up to eight stored recordings (alarm number, recording date and time) along with a preview window offers the user an easy way of searching and playing back a particular event. You can easily switch to a full screen display and display a still picture, or perform a fast-forward search simply by turning the shuttle or jog dial.

**Motion Detection Search**

By setting a motion detection search on the monitor screen, it is possible to pick up a portion of a recording in which some activities are taking place due to an intruder or some other action. If the unit is connected to a multiplexer, which is capable of interpreting the camera channel information, it is also possible to pick up recordings by designating a camera number.

In addition, with the digital recording technology, the user can view a noise-free picture in a fast-forward or fast-rewind search.

**Jog / Shuttle Controller**

The jog / shuttle controller offers a simple and user-friendly interface that lets users operate the unit in the same manner they operated conventional time lapse VCRs.



The jog dial and the shuttle ring allow users to view recorded images frame by frame or in fast-forward mode by simply turning them left or right.

**SSP Compatible**

DSR-3000P is compatible with SSP (Sanyo Security Serial Protocol) signal, the bi-directional communication protocol for security equipment proposed by Sanyo. By using SSP, it is possible to control cameras, multiplexers, and recorders (up to 255 units in total) from a single controller.

**Flexible System Configuration Best Suited to User Needs**

DSR-3000P allows users to construct a system best suited to their needs by integrating various units, such as Quad Compressors, 4 / 9 / 16 channel Multiplexers, etc. This flexibility allows users to build a system with minimum investment.

- X2 electronic zoom
- Audio recording (with high speed video recording of 8 fields/sec.)
- Two-level password security lock (operation / setup)
- Push-lock terminals for easy installation (refer to the rear panel photo)
- Video loss alarm
- 30-day memory back-up
- Resume function
- End-of-medium alarm
- On-screen mode setting, menu languages built in: English / French / German / Spanish
- Built-in time date generator
- Timer recording
- Auto repeat recording
- Master / slave clock adjustment
- Alarm recording
- Alarm counter
- Forward / reverse field advance
- Automatic summer time adjustment
- Lifetime counter
- Through output of video
- RS-232C compatible

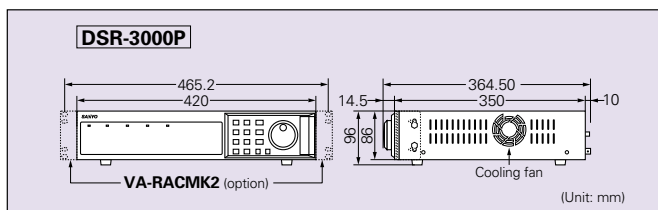

**Highly Compatible with PCs**

**CF Type II Expansion Slot**

DSR-3000P allows the user to copy recorded data onto Compactflash or a Microdrive, which allows data to be easily transferred to a PC.

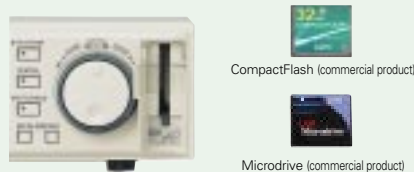

**PC Card Slot**

An PCMCIA LAN card, commercial product, offers a LAN connection (Ethernet 10Base-T) with which any PC in the network can be used to monitor and setup the DSR-3000P. The access level can be controlled by setting passwords.



For information on recommended PC LAN cards and compatible PCs, visit our website at [www.sanyosecurity.com](http://www.sanyosecurity.com).

By using a PC SCSI card (commercial product), the user can make backup copies of video and audio data from the built-in HDD on to a DAT recorder.

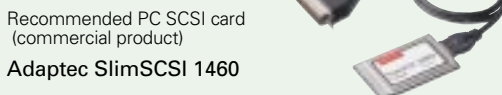

**Distribution of Video Image with E-mails**

Since recorded images are in JPEG format, it is possible to attach images to e-mails or other electronic documents without further processing. This offers a quick and easy solution in sharing information with many people.

MODEL	DSR-3000P
<b>General</b>	<b>Picture resolution</b> 720 x 288 (Field) , 720 x 576 (Frame) <b>Compression</b> M-JPEG <b>Picture quality</b> 5 levels (Basic, Normal, Enhanced, Fine, Super Fine) <b>Recording type</b> Frame or Field recording <b>Recording speed</b> 27 levels. <b>Recording Area</b> Normal Recording Area / Alarm Recording Area / Archive Area <b>Menu language</b> English / French / German / Spanish <b>Clock setup</b> Date, month, year, hour, minute, second
<b>Search Mode</b>	<b>Time/Date Search</b> Search by time and date <b>Alarm Search</b> Search by alarm event list <b>Alarm Thumbnail Search</b> Search by alarm event thumbnails <b>Archive Area Search</b> Search Archive Area with event list <b>Motion detection search</b> Search by specifying a motion sensor in the play back mode
<b>Video</b>	<b>Video input</b> Mini-DIN 4-pin x 1 (S-VIDEO) / BNC x 1 <b>Video output</b> Mini-DIN 4-pin x 1 (S-VIDEO) / BNC x 1 <b>Through output</b> Mini-DIN 4-pin x 1 (S-VIDEO) / BNC x 1 <b>Digital transport in</b> RJ-45 x 1, RJ-45 x 1 (sub) <b>Digital transport out</b> RJ-45 x 1, RJ-45 x 1 (sub)
<b>Audio</b>	<b>Audio input</b> -8 dBs 27 kohms unbalanced, RCA x 1 <b>Audio output</b> -8 dBs 600 kohms unbalanced, RCA x 1 <b>Microphone input</b> -60 dBs 10 kohms unbalanced, 3.5 mm mini jack x 1
<b>Interface</b>	<b>CompactFlash slot</b> CF type 2 (front panel) <b>PC card slot</b> PCMCIA type 2 (rear panel) for SCSI or LAN card
<b>Control signal</b>	<b>RS-232C</b> D-SUB 9-pin (for PC) <b>RS-485</b> Push lock x 3 terminals(A, B, GND) <b>R/C in</b> 1 input for resistor alley switch <b>Alarm in</b> 1 input (Normal Open Low level active) <b>Alarm out</b> 1 output (Normal 5 V Low level active) <b>Alarm reset</b> 1 input (Normal Open Low level active) <b>SW out</b> 1 output (Normal 5 V Low level active) <b>Non rec out</b> 1 output (Normal 5 V Low level active) <b>Clock set in</b> 1 input (Normal Open Low level active) <b>Clock set out</b> 1 output (Normal 5 V Low level active) <b>Warning out</b> 1 output (Normal 5 V Low level active) <b>Disk full out</b> 1 output (Normal 5 V Low level active) <b>Alarm full out</b> 1 output (Normal 5 V Low level active)
<b>Electrical</b>	<b>Power source</b> 220 to 240 V AC, 50 Hz <b>Power consumption</b> Approx. 27 W
<b>Physical</b>	<b>Operating consumption</b> Temperature: 5°C to 40°C [41°F to 104°F], Humidity: 80% or less <b>Dimensions (W x H x D)</b> 420 x 86 x 364.50 mm <b>Weight</b> 5.5 kg [12.1 lbs.]

Warnings regarding HDDs  
 • Do not attempt to install or replace a HDD on your own. You cannot use these HDDs on PCs.  
 • The unit may be damaged if it is exposed to an impact or vibration, or the power plug is disconnected during operation.  
 • Sanyo will not be held liable for any data loss due to an HDD error or a failure during recording.

— Analog video signal    — Analog video and SSP overlay signal (One cable)  
— SSP signal    — Digital video signal

## System Example No.1

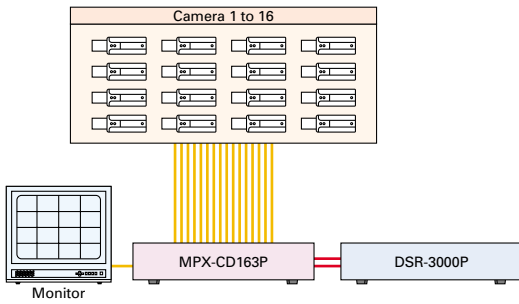

## System Example No.2

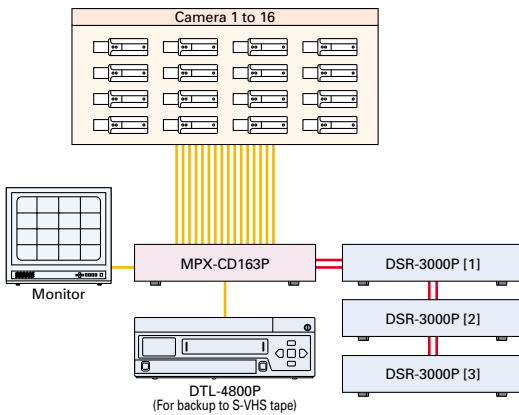

## System Example No.3

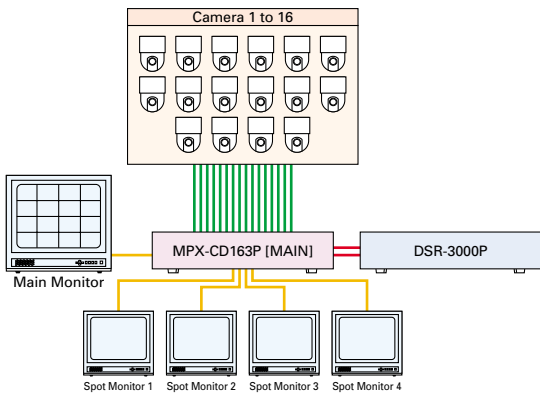

## System Example No.4

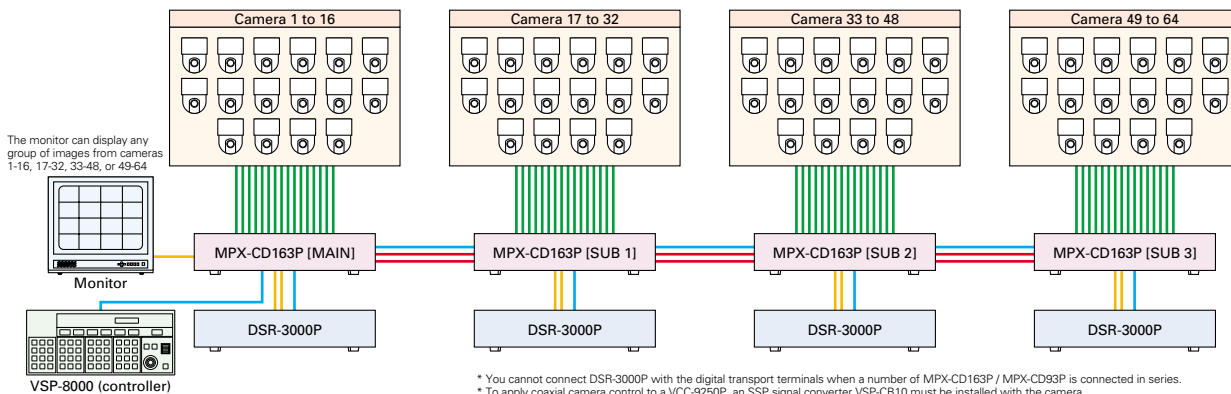

## Horizontal 520 TV Lines corresponding devices

### Camera

**Standard**  
Minimum illumination  
**1 lux**



**VCC-6574P**  
(24V AC type)

**High-sensitivity**  
Minimum illumination  
**0.3 lux**



**VCC-6594P**  
(24V AC type) Available soon

**Pan Tilt Zoom**  
Minimum illumination  
**2.0 lux**



**Line-operate**  
Minimum illumination  
**1 lux**



**Day/Night**  
Minimum illumination  
**0.03 lux (B/W)**



**VCC-4594P** New  
(24V AC type)

**SSP coaxial camera control compatible**



### Multiplexer



### Recorder

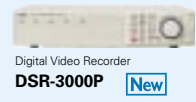

### Monitor



## SSP corresponding devices

### SSP System Unit

SSP System Controller  
**VSP-8000** New



SSP Signal Converter  
**VSP-CB10** New



SSP Signal Receiver  
**VSP-RV200** New



### Camera

1/3" Colour CCD DSP High-resolution Intelligent Dome-shaped Camera  
**VCC-9300P** Available soon



1/3" Colour CCD DSP High-resolution Intelligent Dome-shaped Camera  
**VCC-9250P**

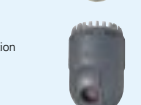

1/3" Colour CCD DSP High-resolution Camera  
**VCC-6975P**



### Multiplexer

16-channel Digital Transport Duplex Multiplexer (Colour) **MPX-CD163P**

16-channel Duplex Multiplexer (Colour) **MPX-CD162P**

16-channel Duplex Multiplexer (B/W) **MPX-MD162P**

9-channel Digital Transport Duplex Multiplexer (Colour) **MPX-CD93P**

9-channel Duplex Multiplexer (Colour) **MPX-CD92P**

9-channel Simplex Multiplexer (B/W) **MPX-MS92P**

### Recorder

Digital Video Recorder **DSR-3000P**

Digital Real Time VCR **DTL-4800P**

960-hour Recording Time Lapse VCR **TLS-9960P**

168-hour Recording Time Lapse VCR **TLS-9168P**

24-hour Recording Time Lapse VCR **TLS-9024P**

S-VHS 960-hour Recording Time Lapse VCR **TLS-S8000P**

168-hour Recording + Real Time VCR **SRT-7168P**

40-hour Recording Real Time VCR **SRT-6000P**

\* You cannot connect DSR-3000P with the digital transport terminals when a number of MPX-CD163P / MPX-CD93P is connected in series.  
 \* To apply coaxial camera control to a VCC-9250P, an SSP signal converter VSP-CB10 must be installed with the camera.  
 \* Maximum cable length for communication, SSP signal: Up to 1200 m



MPX-CD163P front panel

## Digital Transport Duplex Multiplexer

**MPX-CD163P** 16-channel PAL  
**MPX-CD93P** 9-channel PAL

### The Hub of Security Systems

MPX-CD163P / MPX-CD93P are designed to be the hub of security systems that connect cameras, recorders, and monitors by processing three different types of signals — digital video signals, analog video signals, and Sanyo's SSP (Security Serial Protocol) signals. They are a new type of multiplexer that makes it possible to connect and operate different units in harmony, making the best of each unit.

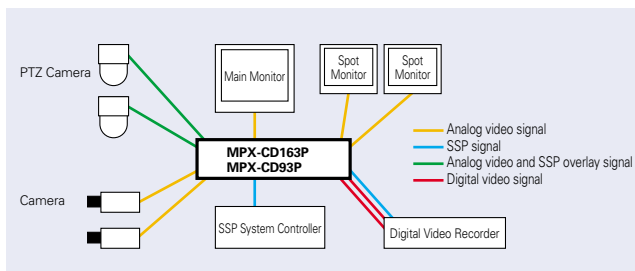

### Digital Transport Terminals (Digital-to-Digital)

MPX-CD163P / MPX-CD93P are equipped with Digital Video In / Out terminals to accommodate data transfer to and from a digital video recorder DSR-3000P without any conversion into an analog signal. The digital-to-digital connection is a key element in reducing video signal deterioration and achieving the amazingly high horizontal resolution of more than 520 TV lines.

☞ Refer to the "System Example No.1 / No.2 / No.3" on page 4.

### Built-in SSP Controller and Coaxial Camera Control

MPX-CD163P / MPX-CD93P come with a controller for SSP (Sanyo Security Serial Protocol) signal, the bi-directional communication protocol for security equipment proposed by Sanyo. From the front panel of these units, the user can control PTZ dome cameras and digital video recorders. Since the SSP signal is overlaid on to the video signal, a connection with a PTZ dome camera can be established simply with a single coaxial cable.

☞ Refer to the "System Example No.3 / No.4" on page 4.

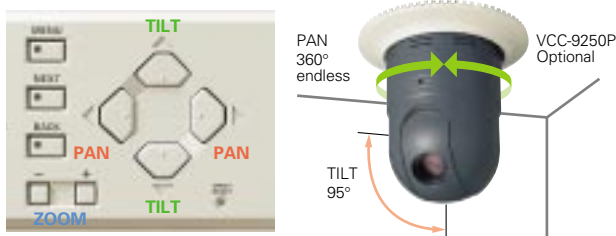

\* To apply coaxial camera control to a VCC-9250P, an SSP signal converter VSP-CB10 must be installed with the camera.



MPX-CD93P front panel

### Mini Matrix Switcher Function

In addition to the main monitor output terminal, four spot monitor terminals are provided. Each channel is capable of displaying any one of sixteen camera images in full screen or all camera images sequentially (The switching interval, 1-30 seconds, can be set independently for each channel.)

Spot monitor 1 may be used to display the same images as the main monitor.

☞ Refer to the "System Example No.3" on page 4.

### Series Connection for up to 4 Units

The Digital Video In / Out terminals allow up to four MPX-CD163P / MPX-CD93P, to be connected in series, to display images from a maximum of 64 cameras on one main monitor.

☞ Refer to the "System Example No.4" on page 4.

### Multiplex Recording with 1-Field Switching

MPX-CD163P / MPX-CD93P allow users to record all camera images on the recorder with 1-field switching.

### Extensive Display Options

For both live picture monitoring (during multiplex recording) and replay of recorded pictures, the user can select from 16-screen display, 9-screen display, 4-screen display, and full-screen (1-screen) display.

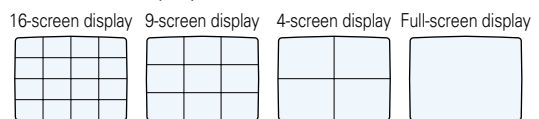

MPX-CD93P does not support the 16-screen display function.

• Plus display: Pressing on the Plus Display button in 16- or 9-screen display mode will bring up a plus display screen on the lower right corner occupying 1/4 of the screen. The plus display screen is capable of displaying a live video image at a speed of 50 fields/sec. for better surveillance. The user may select any one of the sixteen camera images or a sequential display of all camera images for the plus display screen.

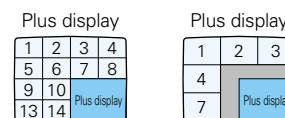

MPX-CD93P can display the images from cameras 1 to 9, for plus display.

• Playback during Live Surveillance: During live surveillance, the user can review a recorded video by displaying it on the plus display screen. This function allows you to take advantage of simultaneous recording and playback using only one monitor, when recording with digital video recorder DSR-3000P.

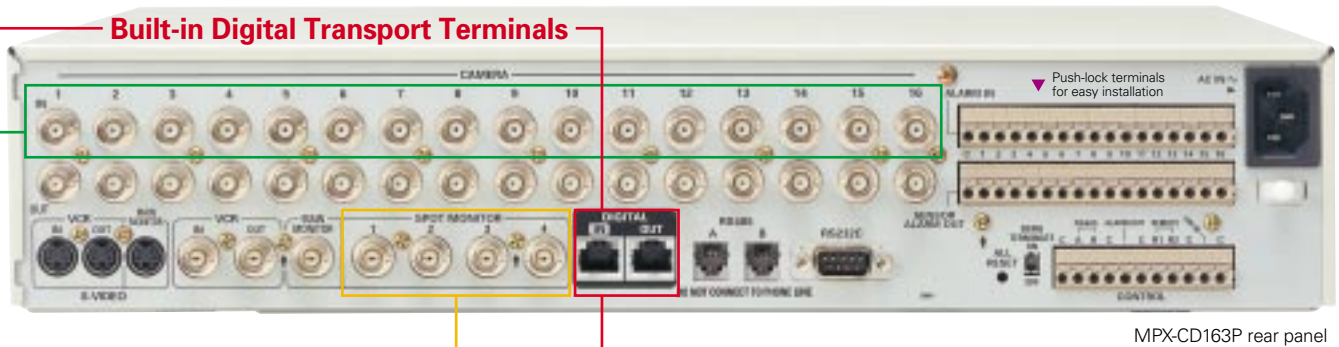

MPX-CD163P rear panel



MPX-CD93P rear panel

- 4-screen display: Each of the four display areas may be set to display any camera image or series of camera images sequentially (switching interval 1-30 seconds.)
- Full-screen display: The entire screen may be set to display any camera image or series of camera images sequentially (switching interval 1-30 seconds, independently set for each camera). Full-screen display can both zoom to x2 and viewed as still images. (Available on live pictures and recorded pictures)
- Screen position assignment: Each camera image can be assigned to any location on the screen in 16-screen and 9-screen display mode. For example, images from critical security points can be placed in the center without any re-wiring. You can also assign images in 4-screen display mode.

Example: Pictures #1, #2, #3 and #4 are replaced by #6, #7, #10 and #11

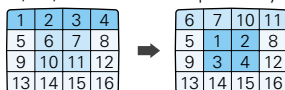

- Monitor masking: It is possible to hide particular pictures (such as ones from hidden cameras) on the monitor. This setting does not affect multiplex recording, in which all camera images are recorded.

Example: Pictures #15 and #16 are masked

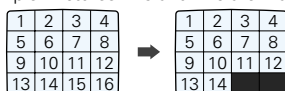

**Active Recording**

By setting up video sensors for each camera, it is possible to trigger an active recording whenever a change in brightness is detected. The duration of an active recording can be specified between 1-180 seconds. An active recording may be triggered by an alarm input from an external sensor.

Sensor positions are indicated by the letters "A" and "B" on the screen. A total of 160 points per one camera are assigned for sensors A and B. The location of each sensor can be set by the user, and sensor sensitivity is adjustable camera by camera.

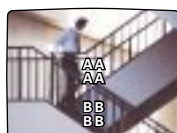

- Five detection modes are available for each camera image as follows:
  - **Mode A:** Alarm is triggered by a brightness change on sensor A
  - **Mode A and B:** Alarm is triggered by simultaneous brightness change on both sensors A and B. (Disregard movement of small objects such as small animals.)

- **Mode A and NB:** Alarm is triggered when there is a brightness change on sensor A but not on sensor B. (Disregard brightness changes in the whole area due to lighting conditions.)
- **Mode A to B:** Alarm is triggered when there is a change in brightness in the direction of sensor A to sensor B.
- **Mode C:** Alarm is triggered when there is a constant change in brightness for the entire screen. (Detects the spraying of paint, etc., on the camera.)

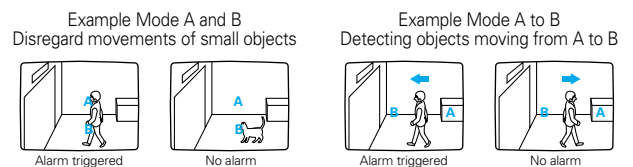

An active recording may be performed in mode 1 (alternate recording A), mode 2 (alternate recording B), or mode 3 (continuous recording).

**Mode 1 (alternate recording A)**



**Mode 2 (alternate recording B)**

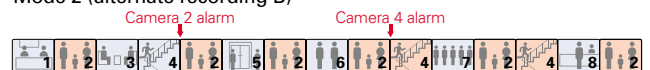

**Mode 3 (continuous recording)**



**Alarm Functions**

Using the built-in video sensor and external sensors, the following alarm functions are available.

(1) Monitor Display Switching

An alarm signal causes the monitor to switch to the designated mode of display (16-, 9-, or full-screen). It also causes letters "SA" (for a video alarm) or "EA" (for an external alarm) to be displayed alternately with the camera title. The user can also set each spot monitor to switch to the image from the camera from which the alarm was triggered.

(2) Buzzer and Indicator Lamp Warnings

An alarm signal triggers a buzzer sound as well as the blinking of the camera selection indicator light for the relevant camera.

The duration of an alarm operation for an individual camera can be set either to a fixed period between 1 – 180 seconds, CC (while the alarm is ON), or NC (until the system is reset). Every time an alarm signal is received, the camera number, date, and time are added to the alarm log stored in the unit's memory (up to 100 events).

(ALARM LIST) 1/13					(ALARM LIST) 2/13				
CAM	DATE	TIME	ITEM		CAM	DATE	TIME	ITEM	
1	4	08-22	20:48	E	9	7	08-22	11:40	E
2	8	08-22	19:51	S	10	8	08-22	10:49	S
3	5	08-22	18:22	E	11	4	08-22	09:25	E
4	3	08-22	16:45	V	12	3	08-21	20:15	S
5	6	08-22	16:37	E	13	5	08-21	19:18	E
6	1	08-22	16:26	S	14	1	08-21	18:30	V
7	2	08-22	15:31	V	15	2	08-21	18:21	S
8	7	08-22	12:51	S	16	6	08-21	17:34	E

## Timer Functions

By dividing a day into four time periods T1, T2, T3, and T4, you can set up independent setting in each time period, for each of the following functions.

### (1) Programmed Recording

Only record images from a particular camera depending on the time period. Also, the number of fields to be recorded by the camera can be set independently for each time period.

### (2) Monitor Masking

### (3) Display Interval for Full-screen Sequential Display

### (4) Built-in Video Sensor Settings

For each time period, the positions of video sensors and sensitivity can be set independently for each camera.

## Video loss alarm

When a video signal is lost due to an accident or a fire, a buzzer will notify the user of the incident. The monitor display will freeze with a still image of the most recently received image or switch to a test pattern, along with a blinking display of "VIDEO LOSS" message (still image / test pattern option is

selectable). Every time a lost signal is detected, the camera number, date, and time will be added to the alarm log.

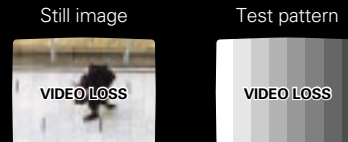

- Two-level password security lock (operation / setup)
- Asynchronous
- Position adjustable camera titles (10-character)
- One push adjustable clock
- Automatic summer time adjustment
- On-screen mode setting, menu languages built in: English / French / German / Spanish
- RS-232C compatible
- Push-lock terminals for easy installation (refer to the rear panel photo)

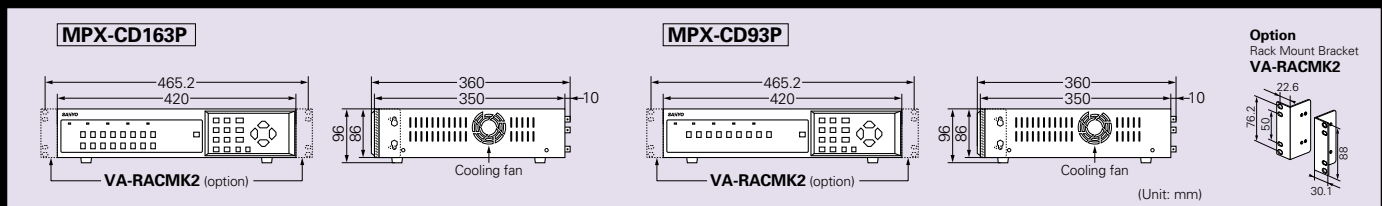

MODEL	MPX-CD163P	MPX-CD93P		
<b>General</b>	<b>Number of cameras</b>	16	9	
	<b>Number of alarm inputs</b>	16	9	
	<b>Pixel resolution</b>	720 x 564	720 x 564	
	<b>Colours</b>	8 bit 16,777,216	8 bit 16,777,216	
	<b>Gray scale</b>	256	256	
<b>Video</b>	<b>Signal format</b>	PAL standard (colour) / CCIR standard (B/W) auto select, 625 lines, 50 fields/sec.	PAL standard (colour) / CCIR standard (B/W) auto select, 625 lines, 50 fields/sec.	
	<b>Video input</b>	1.0 V (p-p) 75 ohms unbalanced	1.0 V (p-p) 75 ohms unbalanced	
	<b>Video output</b>	1.0 V (p-p) 75 ohms unbalanced	1.0 V (p-p) 75 ohms unbalanced	
<b>Time / Date generator</b>	<b>Functions</b>	Date, month, year, hour, minute, second	Date, month, year, hour, minute, second	
	<b>Battery backup</b>	30 days	30 days	
<b>Alarm commands</b>	<b>Input</b>	Ground contact closure	Ground contact closure	
	<b>Output</b>	+5 V at 5.7 kohms	+5 V at 5.7 kohms	
<b>Connectors</b>	<b>Digital transport</b>	<b>Input / output</b>	RJ-45 x 1 / RJ-45 x 1	RJ-45 x 1 / RJ-45 x 1
	<b>For camera</b>	<b>Video input</b>	BNC x 16 (SSP coaxial camera control terminal)	BNC x 9 (SSP coaxial camera control terminal)
		<b>Through output</b>	BNC x 16	BNC x 9
	<b>For VCR</b>	<b>Video input</b>	Mini-DIN 4-pin x 1 (S-VIDEO) / BNC x 1	Mini-DIN 4-pin x 1 (S-VIDEO) / BNC x 1
		<b>Video output</b>	Mini-DIN 4-pin x 1 (S-VIDEO) / BNC x 1	Mini-DIN 4-pin x 1 (S-VIDEO) / BNC x 1
	<b>For main monitor</b>	<b>Video output</b>	Mini-DIN 4-pin x 1 (S-VIDEO) / BNC x 1	Mini-DIN 4-pin x 1 (S-VIDEO) / BNC x 1
	<b>For spot monitor 1</b>	<b>Video output</b>	BNC x 1	BNC x 1
	<b>For spot monitor 2-4</b>	<b>Video output</b>	BNC x 3	BNC x 3
	<b>Others</b>	<b>Alarm input / output</b>	Pushbutton terminal x 16 / Pushbutton terminal x 1	Pushbutton terminal x 9 / Pushbutton terminal x 1
		<b>Sensor alarm output</b>	Pushbutton terminal x 16	Pushbutton terminal x 9
<b>SW input</b>		Pushbutton terminal x 1	Pushbutton terminal x 1	
<b>SSP (RS-485)</b>		RJ-11 x 2, Pushbutton terminal x 1 pair	RJ-11 x 2, Pushbutton terminal x 1 pair	
<b>RS-232C</b>		D-sub 9-pin x 1	D-sub 9-pin x 1	
<b>Electrical</b>	<b>Power source</b>	220 to 240 V AC, 50 Hz	220 to 240 V AC, 50 Hz	
	<b>Power consumption (approx.)</b>	18 W (180mA)	17 W (170mA)	
<b>Physical</b>	<b>Operation temperature</b>	5°C to 40°C [41°F to 104°F]	5°C to 40°C [41°F to 104°F]	
	<b>Dimensions</b>	420(W) x 86(H) x 360(D) mm [16.5(W) x 3.4(H) x 12.8(D) in.]	420(W) x 86(H) x 360(D) mm [16.5(W) x 3.4(H) x 12.8(D) in.]	
	<b>Weight (approx.)</b>	5 kg [11.0 lbs.]	5 kg [11.0 lbs.]	

\*Specifications subject to change without notice

**\* Caution:** please consult the instruction manual to ensure safe and proper operation of the product.

Distributed by:

# SANYO

SANYO Electric Co., Ltd.  
Video Imaging Systems Division  
www.sanyosecurity.com  
©2001 SANYO Printed in Japan '01.12. AP  
SMS-023