



OPTiMAL

Specifications

Model	OML-ST	OML-AM	OML-DT	OML-DAM
Detection method	Passive infrared		Passive infrared & Microwave	
Detector standard	prEN50131-2-2 (Grade 2)	prEN50131-2-2 (Grade 3)	prEN50131-2-4 (Grade 2)	prEN50131-2-4 (Grade 3)
Masking detection method	—	AIR type	—	AIR type
PIR Coverage (Detection zones)	15m x 15m (50ft. x 50ft.) 85° wide (82 zones)			
Power supply	9 - 18V DC			
Current consumption	16mA (normal)/18mA (max.) at 12V DC	22mA (normal)/23mA (max.) at 12V DC	19mA (normal)/24mA (max.) at 12V DC	25mA (normal)/29mA (max.) at 12V DC
Alarm output	N.C. 28V DC 0.2A max.			
Tamper switch	N.C. Opens when cover is removed and when the wall tamper switch operates. 28V DC 0.1A max.			
Trouble output	—	N.C.28V DC 0.2A max.	—	N.C.28V DC 0.2A max.
Operating temperature	-10°C - +50°C (14°F - 122°F)			
Environmental humidity	95% max.			
RF interference	No alarm 30V/m			
Mounting height	1.8 - 3.0m (6 - 10ft.)		1.8 - 2.4m (6 - 8ft.)	
Weight	180g (6.3oz)			

*specifications and design are subject to change without prior notice

Detection area

WIDE ANGLE

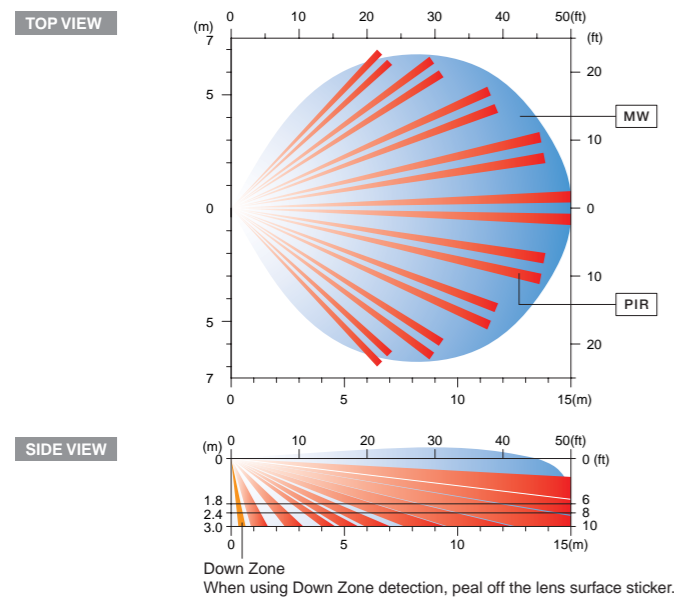

LONG RANGE (when using CL-80N) (OML-ST only)

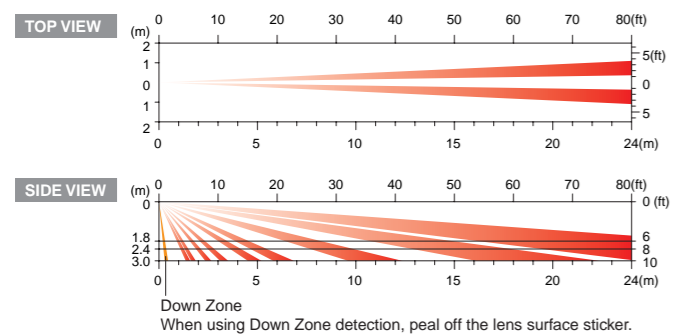

Dimensions

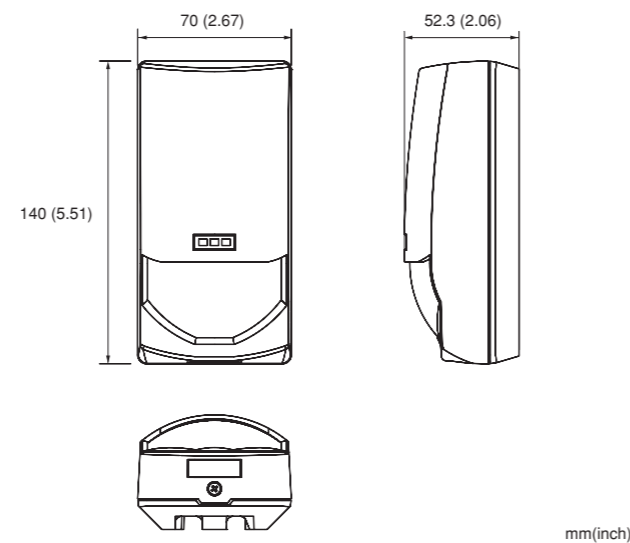

OPTION

FA-3

Wall Mount Bracket



FA-1W

Compact Wall & Ceiling Bracket



NOTE:

This unit is designed to detect movement of an intruder and activate an alarm control panel. Being only a part of a complete system, we cannot accept responsibility for any damages or other consequences resulting from an intrusion. This product conforms to security product category of EMC Directive 89/336 EEC.



The **OPTiMAL**, complies with EN50131-1 and provides a comprehensive product lineup from standard to high-end models suitable for any applications. Its stylish single housing design offers unobtrusive installation and a uniform appearance across the range.



OPTEX CO., LTD. (ISO 9001 Certified by LRQA / ISO14001 Certified by JET) □
 5-8-12 Ogino, Otsu, Shiga, 520-0101 Japan □
 TEL +81(0)77 579 8670 FAX +81(0)77 579 8190 <http://www.optex.co.jp/e/>
OPTEX INCORPORATED (USA) □ <http://www.optexamerica.com>
OPTEX (EUROPE) LTD. (UK) □ <http://www.optex-europe.com>
 (ISO9001 Certified by NQA) □ <http://www.optex-security.com>
OPTEX SECURITY SAS (FRANCE) □ <http://www.optexkorea.com>
OPTEX KOREA CO., LTD. (KOREA) □ <http://www.optex.com.pl>
OPTEX SECURITY Sp. z o.o. (POLAND) □ <http://www.optexchina.com>
OPTEX (DONGGUAN) CO., LTD. □
 Shenzhen office (CHINA)

HIGH-END INDOOR DETECTOR
OPTiMAL

High-End Indoor Detector
with Comprehensive
Product Lineup

The OPTiMAL, Grade 2 or Grade 3 detectors provide a comprehensive product lineup from standard to high-end models suitable for any applications. It delivers high performance and unsurpassed stability in any risk application or environmental conditions. Whatever the requirement OPTiMAL technology fills the gaps left by others.



Features

GRADE 3 full compliance

	EN GRADE	PIR	microwave	active IR anti-Masking
OML-ST	GRADE 2	●		
OML-AM	GRADE 3	●		●
OML-DT	GRADE 2	●	●	
OML-DAM	GRADE 3	●	●	●

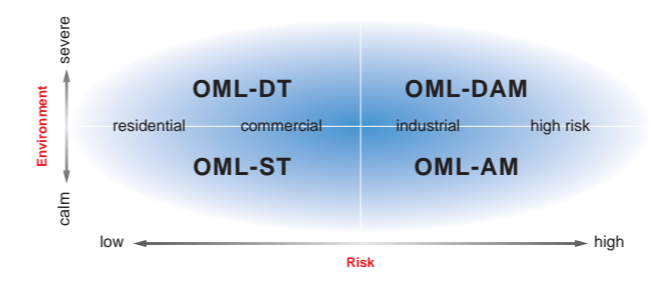

Microwave control switch

OML-DT OML-DAM

If required, the microwave operation can be automatically disabled when a system is disarmed. This function reduces current consumption and exposure to microwave emissions.

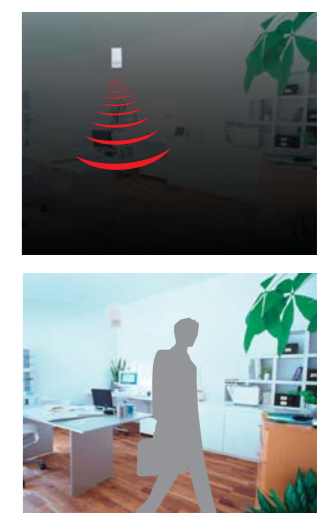

OPTiMAL anti-masking

OML-AM OML-DAM

OPTiMAL automatically optimizes the anti-masking technology to match changing environmental conditions, delivering consistent, reliable performance.

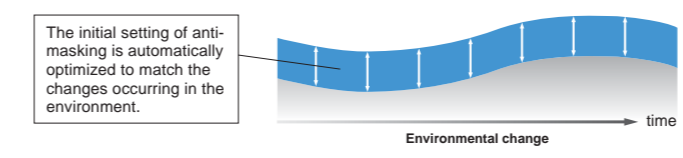

EOL(End-of-line) resistors

Alarm, Trouble and EOL resistors help reduce installation time and minimize connection errors.

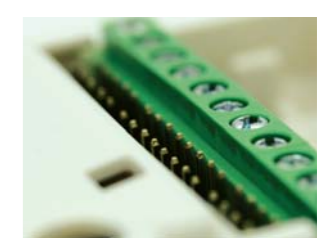

Basic Performance

Double Conductive Shielding to reduce false alarms caused by unwanted light and RFI sources

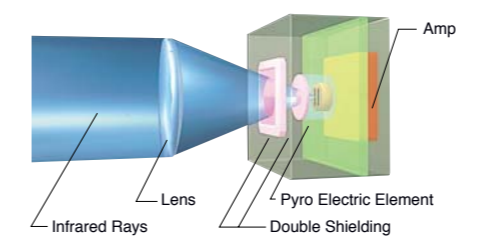

Advanced temperature compensation

It automatically increase the detector's sensitivity under high temperature conditions, especially where the background temperature ranges from 35 – 37°C (63 - 67°F), close to that of the human body.

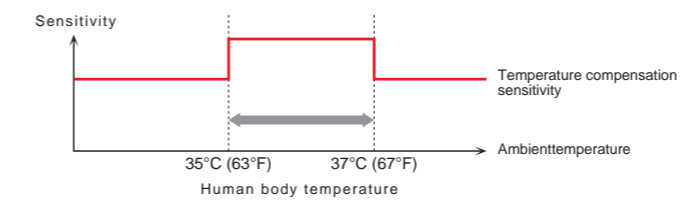

Patented Quad Zone Logic

It creates an extremely high vertical zone density to capture the entire body mass and enable detection of even the smallest temperature contrast against the background.

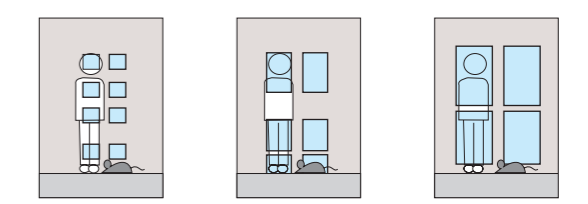

Microwave area shaping technology

It creates the ideal detection area by matching the microwave detection area to that of the PIRs.

