



Model NV-716J-PVD Cable Integrator Hub



Features:

- Connectivity for up to sixteen cameras, each via a single RJ45 4-pair cable
- Use with the NV-216A-PV, NV-218A-PVD, or NV-226J-PV transceiver at the camera
- Uses any third-party power supply to power cameras via UTP over significant distances (see Power Distance Chart)
- Cable-management solution from the camera to the Wiring Closet and on to the Control Room
- 1U high; 1" deep; wall or rack-mountable
- Limited lifetime warranty

Typically installed in the wiring closet or IDF room, the NV-716J-PVD is a passive “pass-through” wiring device that efficiently consolidates camera power, video, and pan/tilt/zoom telemetry data onto a minimum of 4-pair RJ45 cables.

Power, video and data are converted at the camera using a PVD™ transceiver which utilizes a single 4-pair cable with RJ45 connectors to deliver each camera’s signals to the NV-716J-PVD. Up to sixteen cameras are supported. The NV-716J-PVD receives low-voltage camera power from any third-party multi-output Class 2 power supply. Control Room connections are achieved with a single 4-pair RJ45 cable for each group of four cameras. P/T/Z telemetry data, if required, passes through another 4-pair RJ45 cable. Control Room connections may be made using any multi-channel NVT receiver or hub. All equipment employs industry-standard EIA/TIA 568B pinouts.

Network Video Technologies

4005 Bohannon Drive • Menlo Park, CA 94025 • USA
(+1) 650.462.8100 • 800.959.9870 • FAX (+1) 650.326.1940
nvt.com • info@nvt.com



Model NV-716J-PVD

Cable Integrator

Technical Specifications

WIRE DISTANCE (Power Distance Charts)

Supply voltage, wire resistance and minimum camera operating voltage determine the maximum camera distance. Examples assume a minimum 21 VAC at the 24 VAC camera:

Fixed 24VAC Camera		NV-216A-PV	
Power Supply Voltage	24 VAC	28 VAC	
Minimum Voltage at Camera	21 VAC	21 VAC	
B&W Camera 100 mA, 2.4 W			
2-pair 24 AWG	899ft (274m)	2,098ft (640m)	
2-pair 23 AWG (Cat6)	1,134ft (346m)	2,645ft (807m)	
Color Camera 200 mA, 4.8 W			
2-pair 24 AWG	450ft (137m)	1,049ft (320m)	
2-pair 23 AWG (Cat6)	567ft (173m)	1,323ft (403m)	
Color Camera 300 mA, 7.2 W			
2-pair 24 AWG	300ft (91m)	699ft (213m)	
2-pair 23 AWG (Cat6)	378ft (115m)	862ft (269m)	

P/T/Z 24VAC Camera		NV-218A-PVD	
Power Supply Voltage	24 VAC	28 VAC	
Minimum Voltage at Camera	21 VAC	21 VAC	
P/T/Z Camera 1,000 mA, 24 W			
2-pair 24 AWG	90ft (27m)	210ft (64m)	
2-pair 23 AWG (Cat6)	113ft (35m)	265ft (81m)	

Fixed 12VDC Camera		NV-226J-PV	
Power Supply Voltage	24 VAC	28 VAC	
Minimum Voltage at Camera	11.5 VDC	11.5 VDC	
B&W Camera 200 mA, 2.4 W			
2-pair 24 AWG	1,498ft (457m)	2,098ft (640m)	
2-pair 23 AWG (Cat6)	1,889ft (576m)	2,645ft (807m)	
Color Camera 400 mA, 4.8 W			
2-pair 24 AWG	874ft (267m)	1,174ft (358m)	
2-pair 23 AWG (Cat6)	1,102ft (336m)	1,480ft (452m)	

Notes: Wire should be Cat5 or better/ low voltage camera power, video and RS-422 or RS-485 data may reside within the same wire bundle, however do not run 24 or 28VAC within the same wire bundle as other telecom or datacom signals.

VIDEO

UTP, RJ45 Connectors

100 ohms

POWER

16 to 24AWG (0,5mm to 1,3mm)

CAMERA PVD CONNECTIONS

Four front-panel RJ45 outputs support up to four fixed or P/T/Z telemetry cameras over 4-pair UTP.

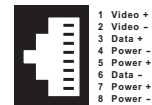

CONTROL ROOM VIDEO

UTP video signals are passed through the unit and delivered to the control/MDF room via rear-panel RJ45 connectors.

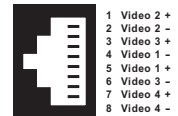

CONTROL ROOM DATA

RS-422 or RS-485 type P/T/Z telemetry/ data signals are paralleled together in groups of four, and passed through the unit and delivered to the control room via a rear-panel RJ45 connector.

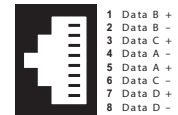

CONTROL

UTP, RJ45 Connectors

100 ohms

ENVIRONMENTAL

Temperature -22 to +167 °F (-30 °C to +75 °C)
Humidity (non-condensing) 0 to 95%

MECHANICAL

Dimensions, excluding brackets and connectors
19in wide x 1.73in high x .8in deep
(482mm wide x 44mm high x 21mm deep)
Weight 0.94lb (0.43kg)
Mounting Rack mount

Specifications subject to change without notice.

Network Video Technologies

4005 Bohannon Drive • Menlo Park, CA 94025 • USA
(+1) 650.462.8100 • 800.959.9870 • FAX (+1) 650.326.1940
nvt.com • info@nvt.com



Model NV-716J-PVD

Cable Integrator

NV-716J-PVD WIRING DIAGRAM

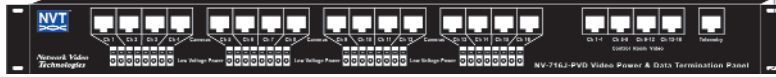

CAMERA CONNECTIONS

Channel 1	Channel 2	Channel 3	Channel 4	Channel 5	Channel 6	Channel 7	Channel 8
1 Video 1+	1 Video 2+	1 Video 3+	1 Video 4+	1 Video 5+	1 Video 6+	1 Video 7+	1 Video 8+
2 Video 1-	2 Video 2-	2 Video 3-	2 Video 4-	2 Video 5-	2 Video 6-	2 Video 7-	2 Video 8-
3 Data A +	3 Data 2+	3 Data 3+	3 Data 4+	3 Data 5+	3 Data 6+	3 Data 7+	3 Data 8+
4 Power 1-	4 Power 2-	4 Power 3-	4 Power 4-	4 Power 5-	4 Power 6-	4 Power 7-	4 Power 8-
5 Power 1+	5 Power 2+	5 Power 3+	5 Power 4+	5 Power 5+	5 Power 6+	5 Power 7+	5 Power 8+
6 Data A -	6 Data 2-	6 Data 3-	6 Data 4-	6 Data 5-	6 Data 6-	6 Data 7-	6 Data 8-
7 Power 1+	7 Power 2+	7 Power 3+	7 Power 4+	7 Power 5+	7 Power 6+	7 Power 7+	7 Power 8+
8 Power 1-	8 Power 2-	8 Power 3-	8 Power 4-	8 Power 5-	8 Power 6-	8 Power 7-	8 Power 8-

Channel 9	Channel 10	Channel 11	Channel 12	Channel 13	Channel 14	Channel 15	Channel 16
1 Video 9+	1 Video 10+	1 Video 11+	1 Video 12+	1 Video 13+	1 Video 14+	1 Video 15+	1 Video 16+
2 Video 9-	2 Video 10-	2 Video 11-	2 Video 12-	2 Video 13-	2 Video 14-	2 Video 15-	2 Video 16-
3 Data C +	3 Data C +	3 Data C +	3 Data C +	3 Data D +	3 Data D +	3 Data D +	3 Data D +
4 Power 9-	4 Power 10-	4 Power 11-	4 Power 12-	4 Power 13-	4 Power 14-	4 Power 15-	4 Power 16-
5 Power 9+	5 Power 10+	5 Power 11+	5 Power 12+	5 Power 13+	5 Power 14+	5 Power 15+	5 Power 16+
6 Data C -	6 Data C -	6 Data C -	6 Data C -	6 Data D -	6 Data D -	6 Data D -	6 Data D -
7 Power 9+	7 Power 10+	7 Power 11+	7 Power 12+	7 Power 13+	7 Power 14+	7 Power 15+	7 Power 16+
8 Power 9-	8 Power 10-	8 Power 11-	8 Power 12-	8 Power 13-	8 Power 14-	8 Power 15-	8 Power 16-

Typical Application

Camera Location and Transmitter Connections

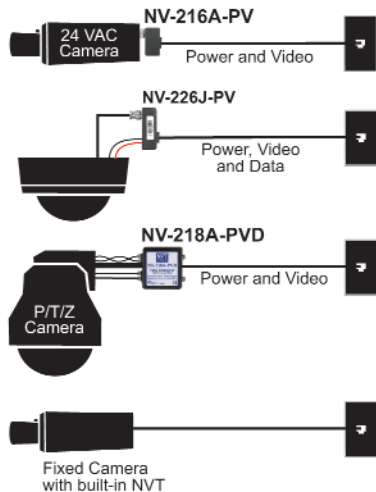

IDF / Telecoms Room Midspan Connections

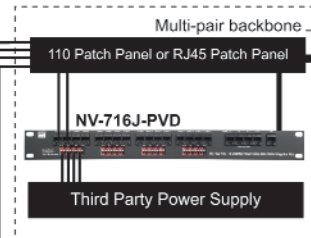

MDF / Control Room Receiver Connections

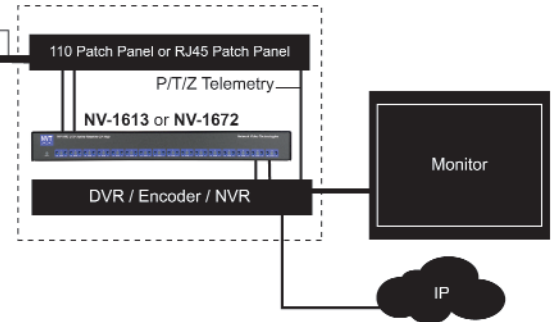

Network Video Technologies

4005 Bohannon Drive • Menlo Park, CA 94025 • USA
 (+1) 650.462.8100 • 800.959.9870 • FAX (+1) 650.326.1940
 nvt.com • info@nvt.com

Copyright © 2008 NVT, Inc.
 411-716-1-F