

SMART TECHNOLOGY THAT CONTROLS LIGHT AND DARKNESS!

Perfect picture quality, powerful security performance

XDI-V 700TVL



LCU5300R

700TV Lines High Resolution IR Bullet Camera

FEATURES

- 6mm (1/3 Type) Exview HAD CCD II
- 2.8~11mm Vari-focal Lens, F1.2
- IR LED : 50m, 32ea
- 650TVL @ Color / 700TVL @ B/W
- Min. illumination
 - Color : 0.03 Lux @ Sens-up Off, F1.2
 - 0.0003 Lux @ Sens-up Auto, F1.2
 - 0.0001 Lux @ Sens-up x512, F1.2
 - B/W : 0 Lux (IR LED ON)
- 2D+3D DNR
- Day & Night with ICR (Infrared Cut-filter Removal)
- Privacy masking : 14 zones
- Motion detection : 8 zones
- RS-485 control & Coaxial Communication (BN/BP)
- IP66
- Dual voltage : 12V DC / 24V AC (BN/BP)

THE LIGHT AMONG THE DARKNESS STUCK OUT LIKE A SORE THUMB

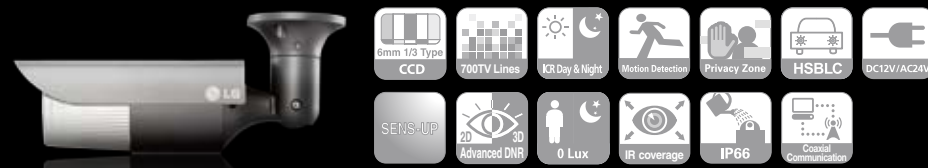

| SPECIFICATION |



Model	LCU5300R-BN	LCU5300R-BP	LCU5300R-EN	
Video	Signal System	NTSC	PAL	NTSC
	Total / Effective Pixels No.	520K / 480K	610K / 570K	520K / 480K
	Imaging Sensor	6mm (1/3 Type) Exview HAD CCD II		
	Horizontal Resolution	650TVL @ Color / 700TVL @ B/W		
	Image Signal Processor	XDI-V		
	Lens Type	2.8~11mm Vari-focal Lens, F1.2		
	Minimum Illumination (30 IRE)	Color :	0.03 Lux @ Sens-up Off, F1.2	
			0.0003 Lux @ Sens-up Auto, F1.2	
			0.0001 Lux @ Sens-up x512, F1.2	
		B/W :	0 Lux (IR LED ON)	
		Day & Night	ICR (Auto / Day / Night)	
	IRIS Control	DC		
	Sync. System	Internal / Line Lock		Internal
	Scanning Frequency (H/V)	15.734 KHz / 59.94 Hz	15.625 KHz / 50 Hz	15.734 KHz / 59.94 Hz
	S/N Ratio	50dB		
Video Output Signal	TVp-p Composite (75Ω)			
IR LED	32 LED's			
IR Distance	50m			
Operational	SmartIR	IR Anti-Saturation		
	Backlight Compensation	BLC / HSBC / Off		
	DNR	2D+3D DNR		
	Exposure	ALC / ELC		
	Auto Gain Control	Off / Low / Middle / High		
	Electronic Shutter Speed	1/60 - 1/120,000	1/50 - 1/120,000	1/60 - 1/120,000
	Sens-up	Off / Auto (x2, x3, x4, ...x512) / Manual (x2, x3, x4, ...x512)		
	White Balance	Auto / ATW (1,700 *K - 11,000 *K) / One Push / Manual		
	Motion Detection	8 Zones		
	Privacy Zone Masking	14 Mask Zones		
	Digital Zoom	x16		
	Digital Effect	Off / V-Flip / Mirror / Rotate		
	OSD Language	English, Chinese, Korean, Japanese, French, Italian, Spanish, Portuguese, Dutch, German, Polish, Russian, Turkish, Arabic, Hebrew		
	Communication	RS-485 (LG, Pelco-D, Pelco-P) Coaxial Communication		RS-485 (LG, Pelco-D, Pelco-P)
	General	Power Source	DC12V / AC24V	
Power Consumption		5.9W @ DC12V, 5.9W @ AC24V		5.4W @ DC12V, 9.9W @ CCU24V
Input Current		DC12V : 490mA / AC 24V : 390mA		DC12V : 440mA / CCU24V : 390mA
Operating Temperature/Humidity		-10°C ~ 50°C / 0% ~ 80%RH		
Storage Temperature/Humidity		-20°C ~ 60°C / 0% ~ 90%RH		
Certifications		FCC, CE, UL, KCC		VCCI
Ingress Protection		IP66		
Dimension (H x V x D)	84(W) x 83.5(H) x 320(D)			
Weight	1.3kg			

| DIMENSION | (Unit : mm)

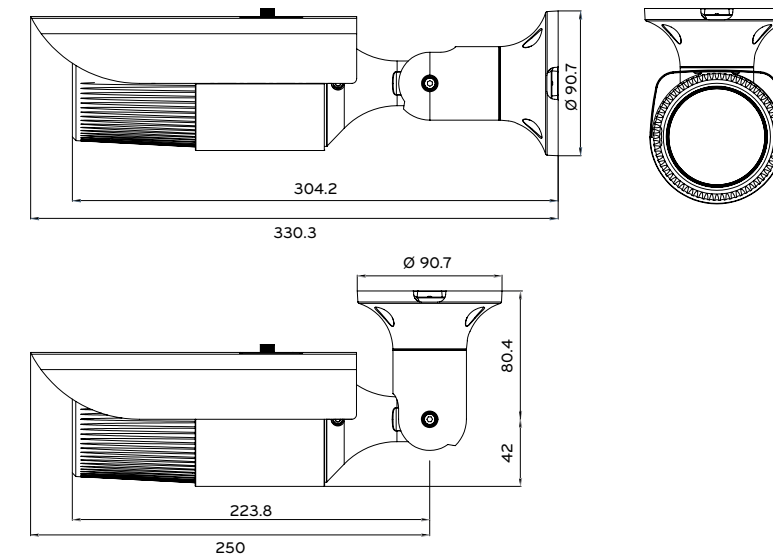

| REAL VIEW |

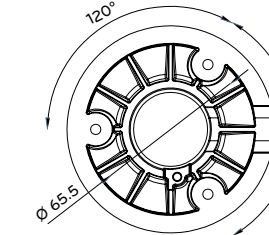

HOME ENTERTAINMENT COMPANY SECURITY OVERSEAS MARKETING TEAM

LG Twin Towers, 20 Yeouido-dong, Yeongdeungpo-gu, Seoul 150-721, Korea
Phone : +82-2-3777-5184 Fax : +82-2-3777-5185
www.LGSecurity.com



The eco-friendly label is attached to those products which have passed LG Electronics' rigorous environmental criteria that evaluate 6 hazardous materials (lead, mercury, cadmium, etc.)

* Exact products and specifications shown may vary by geographic region and are subject to change without notice. Actual products may differ from the images appearing in the catalog.

LG IR CAMERA LCU5300R

LOOKING AT THE DARKNESS!

LG's IR camera has been upgraded in order to adopt the new XDI-V chip technology. With this remarkable technology, LG IR cameras produce the best image quality, intelligent power control, and flexible surveillance to every security application.



XDi-V

THE EXTREME DYNAMIC IMAGE TECHNOLOGY CONTINUES TO EVOLVE



XDi-V ISP Technology is engineered to process high quality images from 520K/610K sensors so as to guarantee 650 TV Lines(color) / 700 TV Lines(B/W). Also, the package size is 46% smaller than the existing one, and the high technology process and low power consumption design reduce power consumption by 20~30%. The newly improved 2D+3D-DNR reduces noise and after-images, enabling an optimal monitoring even at low light. Now experience XDi-V that supports Multi languages and coaxial Communication.

ADVANCED DNR(2D+3D) 2D+3D DIGITAL NOISE REDUCTION

In dark environment, brighter and ghost free images can be obtained by using higher AGC and Image Synthesis Technology.



LOW POWER CONSUMPTION

XDi-V helps low power consumption compared to Conventional through application of high performance & low power DSP and high-efficiency power module.

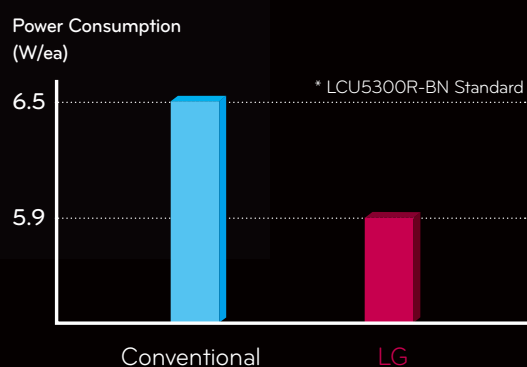

Reduced CO₂ 2.28 kg/yr
 (0.6W x 24hr x 365 days = 5,256 kWh)
 1 Tree = CO₂ 5kg

650 TV Lines (Color) / 700 TV Lines (B/W)

The world best resolution of 650 TV Lines(Color) / 700 TV Lines(B/W) is realized by combined technology of 3 Line filter, edge enhancement and 520K/610K sensor image.

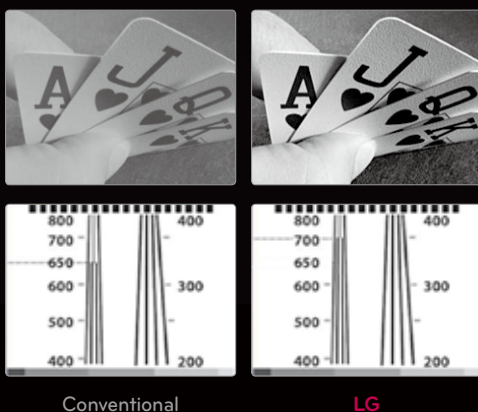

520K / 610K(NTSC/PAL) PIXEL

High Resolution and sharpness can be maintained under strong light source.

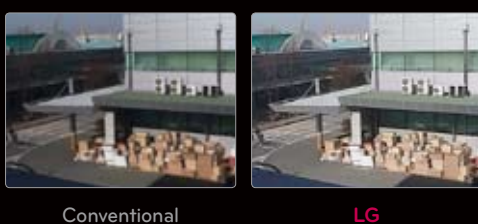

COAXIAL COMMUNICATION

Using a coaxial cable, it can transmit video and control signal.



LIGHT THAT SECURES THE DARKNESS!



WIDE & LONGER IR COVERAGE

Measures a wide IR angle of view at low luminance to reduce dead spots and Provides clear images for a long distance.



INTELLIGENT POWER CONTROL

Conducts a variable control of IR current (PWM) according to scenes to contain a rise in LED temperatures, thereby enhancing LED life.

Enhances LED life by 25% compared with the basic method, due to anti-saturation and variable control of current.

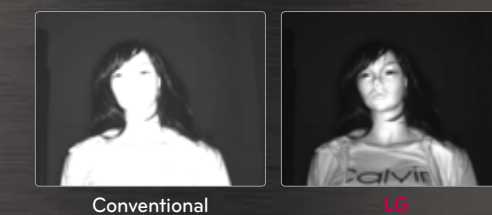

Control Method	Supply of a specific level of power	Current control (application of PWM) [LCU5300R]
IR LED Current	Consumption of maximum current regardless of scenes	Provides optimal current to IR LED to prevent image saturation according to scenes.
Measurement Scene	LED Temperature measured for the same scene	65°C or over
	Expected life	34,000 hr
		60°C or under
		44,000 hr

* PWM : pulse width modulation

IR ANTI-SATURATION

IR control optimization design compensates for surrounding dark areas as much as possible, and prevents saturation.

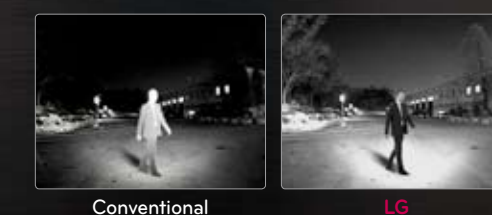

PROVIDES UP TO 50m AMPLE VIEWING RANGE

Making use of IR LED's excellent performance, this product boasts up to 50meters of wide-reaching surveillance.

Furthermore, the highly durable LED provides a long lifespan and strong stability.

