

# HVAC Occupancy Sensor

## OS-550

### GENERAL

The OS-550 is an occupancy sensor designed for automatic ventilation control of HVAC system. This sensor provides a changeover (form C) relay signal output for fan coil controller to activate/deactivate the operation of fan coil automatically. This sensor can be wall or corner mounted with 110°, 15m detection range.

### INSTALLATION HINTS

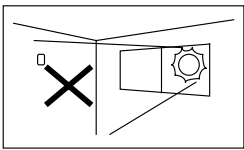

Do not install where the detector is exposed to direct sunlight or directly above strong sources of heat.

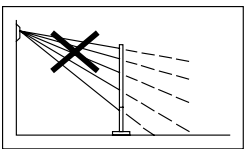

Make sure the detection area does not have any obstruction (plants, large pieces of furniture, curtains etc.) which may block the detection.

### DESCRIPTION

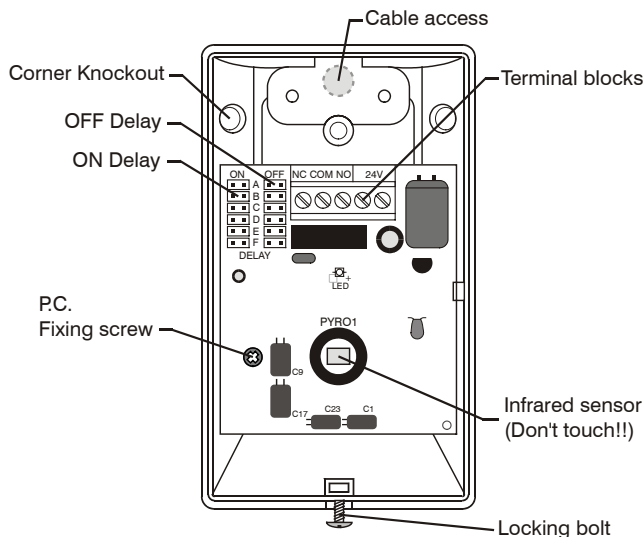

### INSTALLATION & WALK TEST

#### Installation

1. Mount the base of mounting bracket on the selected position. Lead the cable through the access tunnel of mounting bracket.
2. Open the front cover by loosening the locking screw at the bottom. Lead the cable into the unit and assemble the mounting bracket with the unit.
3. Connect the cable to the corresponding terminals according to the following instructions.

## Installation Instructions

#### Wiring Diagram

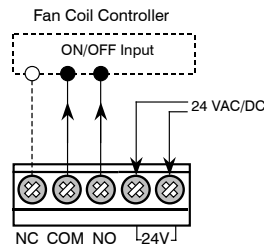

◆ **NC-COM-NO:** Output for ON-OFF control of fan coil operation. Dry contact signal.

◆ **24 V:** Power supply (non-polarity)

4. Replace the front cover and then walk test can be proceeded.

#### Walk Test

Apply the power supply to the sensor and wait for about 25 seconds to warm up. The LED will blink (long-short) during warm up period. Ensure the jumper head connectors of ON and OFF delays are placed on "A" position (shortest delay). Walk across the detection zones (invisible) at normal speed. The LED will lit whenever the sensor detects the motion. *Note: If any jumper head is not properly placed, the LED will blink to indicate.*

#### ■ Ceiling Mount

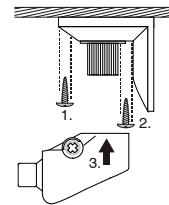

#### ■ Wall Mount

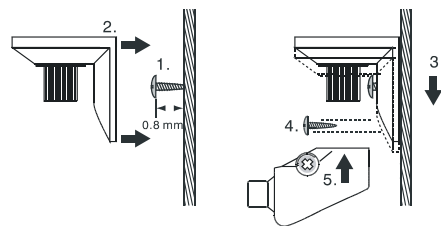

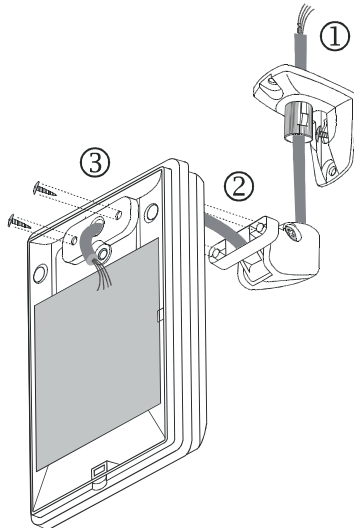

release the screw on the mounting bracket and then carefully move the sensor to the direction desired.

## ON / OFF DELAY

The ON and OFF delays are designed to provide smarter energy management of HVAC system. ON delay is the time given to the sensor to certify the occupancy, before it activates the fan controller. OFF delay is the time that relay is activating. Both ON and OFF delays can be easily set by placing the jumper head on the corresponding pins as following.

	A	B	C	D	E	F
ON	0 sec.	10 sec.	30 sec.	1 min.	5 min.	10 min.
OFF	10 sec.	1 min.	5 min.	10 min.	20 min.	30 min.

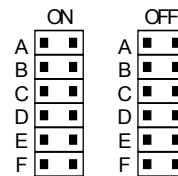

## OPERATION

### Operation Diagram

#### A. Standby

After warm up time expires, the sensor enters into standby mode. Sensor will check whether both delays are properly set.

#### B. Relay ON Delay

Relay ON delay is the time given to sensor to verify true occupancy before activating the relay output. Any further detection during ON delay will NOT reset the timer.

#### C. 1-minute Waiting

When Relay ON delay expires, the sensor enters into an 1-minute waiting time. If no detection within 1 minute, then sensor will return to standby mode. If any detection occurs, then relay output will be activated and Relay OFF delay will be started.

#### D. Relay OFF Delay

Relay OFF delay is the time of relay activating. Every detection during this period will reset the timer.

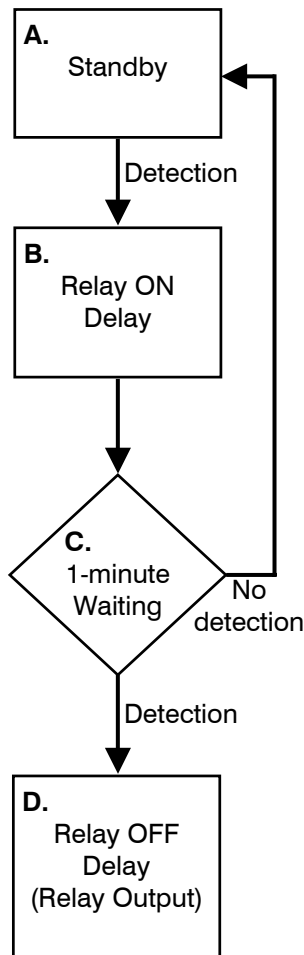

## DETECTION PATTERN

Top view

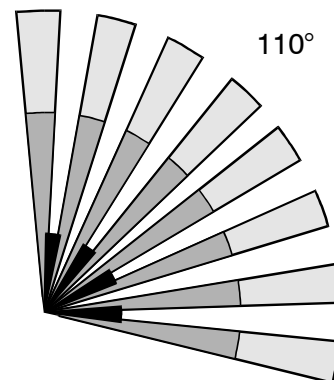

Side view

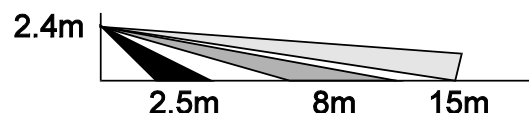

## RANGE ADJUSTMENT

In order to suit different room or area, the detection range of OS-550 can be adjusted by changing the direction of sensor. To change the sensor direction,

## SPECIFICATIONS

Infrared sensor..... Dual element  
 Power supply ..... 24 ± 2 V AC/DC  
 Detection range ..... 15 x 15 m at 25°C

Output format..... Form C, 30 VDC, 0.2A max.  
Current drain..... 5 mA @24 VAC  
Mounting height..... 1.8~3.6 m  
Mounting bracket..... MB-99  
Detectable speed..... 0.1~3.0 m/sec.  
RFI immunity..... Av. 20 V/m (10~1,000 MHz)  
Temperature ..... -20°C~50°C (-4°F ~ 122°F)  
Humidity..... 95% RH max.  
Dimensions ..... 112 x 66 x 45 mm

2002/04/10 058-55002-000 V1.1

