

Network Video Recorders

NVR-AS 3000 Series

Draft pre-release datasheet

Powerful and integrated recording and playback system for video and audio from transmitters and receivers.

IndigoVision offers a suite of Network Video Recorders to suit your requirements. Our family of Standalone Network Video Recorders provides a powerful and integrated recording and playback system for video and audio from transmitters and receivers, with a choice of integrated or removable disks.

All Standalone IndigoVision NVRs can be rack- or desk-mounted and require no additional hardware for operation. They can be located at any point on a network allowing recording and playback across multiple sites regardless of location. A system can deploy as many NVRs as required. Remote NVR management and configuration is performed using an intuitive web-based configuration interface which forms part of IndigoVision's Control Center software.

- Record and playback MPEG-4 and H.264 video and audio streams
- Simultaneous full frame rate recording of up to 64 streams plus playback of up to 20 streams
- 5-Year Disk Warranty
- Redundant network connections
- Internal power supply with redundant power connector
- Optional RAID storage resilience



NVR-AS 3000 Fixed Disk Series:
FD1000 / FD2000

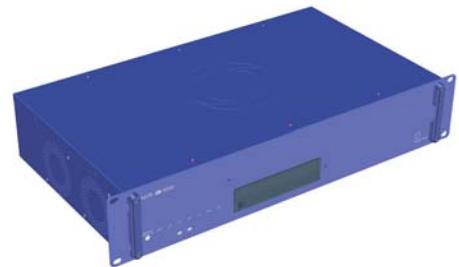

NVR-AS 3000 Single Removable Disk Series:
RD500 / RD1000



NVR-AS 3000 Raid Array Series:
RAID 5 distributed parity: RA1500 / RA3000
RAID 1 mirror configured: RA1000 / RA2000
RAID 0 stripe configured: RA2000 / RA4000

Specification

	FD Series		RD Series		RA Series					
	1000	2000	500	1000	1500	3000	1000	2000	2000	4000
Network Redundancy	Y	Y	Y	Y	Y	Y	Y	Y	Y	Y
Redundant Power Supply	Y	Y	Y	Y	Y	Y	Y	Y	Y	Y
Removable Storage	N	N	Y	Y	Y*	Y*	Y*	Y*	Y*	Y*
Disk Space (GB)	1000	2000	500	1000	1500	3000	1000	2000	2000	4000
Available Storage (GB)	963	1953	482	963	1458	2943	963	1953	1953	3933
RAID	RAID0	RAID0	N	N	RAID5	RAID5	RAID1	RAID1	RAID0	RAID0
Max. Recording Streams	64	64	50	50	TBD	TBD	64	64	64	64
Max. Playback Streams	20	20	20	20	TBD	TBD	20	20	20	20
Max. Recording Bitrate	64	64	64	64	TBD	TBD	64	64	64	64
Max. Playback Bitrate	40	40	40	40	TBD	TBD	40	40	40	40
Performance figures above are for simultaneous recording and playback. RAID5 max. recording streams are reduced to TBD during array rebuild.										
Power consumption	FD Series: 50W max; RD Series: 35W max; RA Series: 80W max									
Physical Dimensions	483x272x87mm (2U)									
Electrical	Operating Voltage: Input 100-240V ~ 47-63Hz 1A. Connector for redundant external power supply									
Network Connections	Two redundant 100/1000 BaseT RJ-45 Connections									
Environmental	Operating temp: TBD; Storage temp: -20 to +70°C/-4 to +158°F									
Onboard Diagnostics	Disk, CPU, Motherboard temperatures. Redundant power and network status									
Regulatory	EN55022 ITE Emission standard Class A; EN61000-3-2 Mains Harmonics Class A; EN61000-3-3 Voltage Fluctuation; EN55024 ITE Immunity standard; CFR47: 2002 Part 15 Sub Part B (US federal code of regulations) UL 60950-01, Information Technology Equipment - Safety - Part 1: General Requirements									
Disks	 Indigo SV35.5 Series optimised for 24x7 video storage. 5-year warranty									

*Removable as a RAID set

Examples of Recording Duration in Days

These tables estimate the amount of recording time in days with different numbers of cameras assuming full frame rate, 4SIF, MPEG4 video. As IndigoVision transmitters only use required bandwidth, the actual recording capacity may be more or less than shown. For more accurate estimates, please see the IndigoVision website or contact IndigoVision's Partner Support.

FD/RA 1000	Motion level	8 cameras	16 cameras	32 cameras	RA 4000	Motion level	8 cameras	16 cameras	32 cameras
Fixed Camera	Low	62	30	15	Fixed Camera	Low	248	120	60
	Medium	50	24	12		Medium	200	96	48
	High	42	20	10		High	168	80	40
PTZ Camera	Low	42	20	10	PTZ Camera	Low	168	80	40
	Medium	36	18	9		Medium	148	72	36
	High	32	16	8		High	128	64	32



Specification

All NVR-AS 3000 variants have the same 2U high, 19" rack housing design with different storage configurations depending on the variant.



View on back face

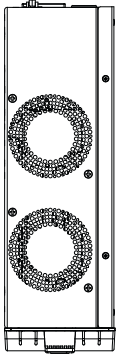

View on left face

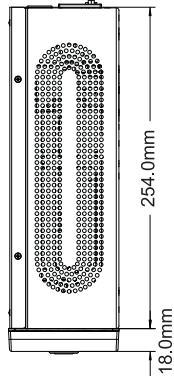

View on right face

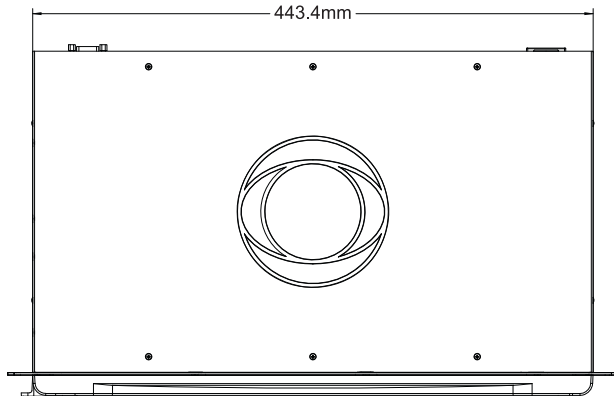

View on top face

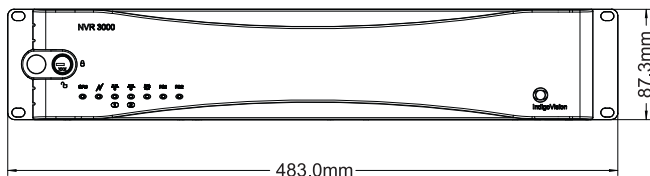

View on front face

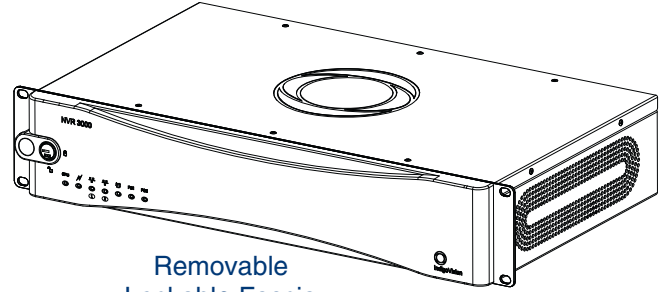

Removable
Lockable Fascia

Front Faces with Fascia Removed

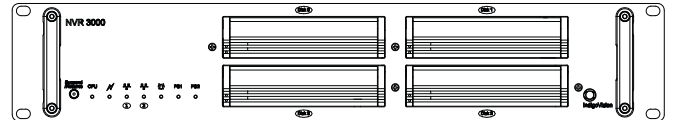

RA Series with 4 x Removable H/Drives

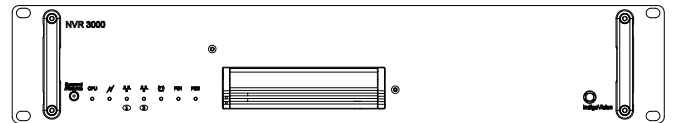

RD Series with 1 x Removable H/Drives

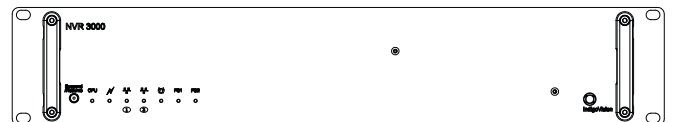

FD Series with 2 x Fixed Internal H/Drives