

2.45GHz Long Range Reader

RF245-3 / RF245-5 / RF245-10



RF245-3 / RF245-5 / RF245-10



RF245 with Bracket



Mounting Bracket

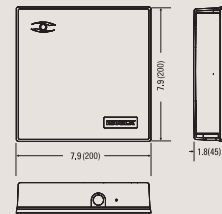

Dimension

EASY TO USE AND INSTALL

Stable read range of 3M, 5M, and 10M guaranteed

KEY FEATURES

- Read range of up to 10M (3M, 5M, 10M)
- Encrypted tag ID and secure protocols between reader and tags
- Multiple tags identification (30tags/sec)
- 90°, one-directional / 360°, omni-directional antenna (Optional)
- 26bit wiegand and RS232 output format
- Direct Bargate output (open collector: 1sec)
- OTR (One Time Reading) and HOLD control input
- Outdoor capacity : IP65

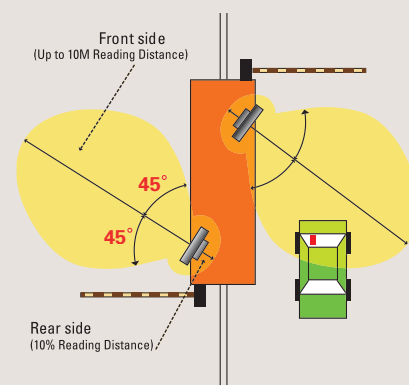

APPLICATIONS

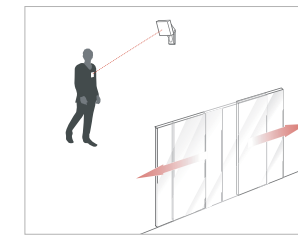

Long Range Access Control
(Hands Free Identification)

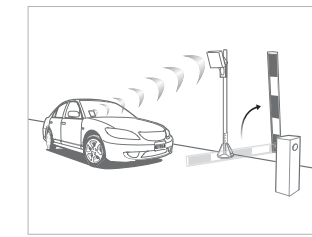

Parking Control
(Vehicle Access Control)

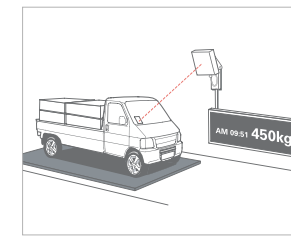

Logistics / Fleet Management
(Weighing Solution)

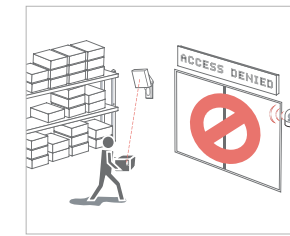

Asset Control

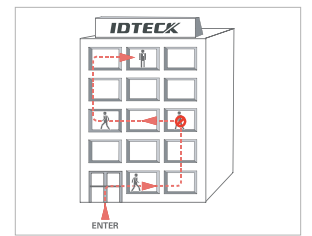

Personnel Tracking

SPECIFICATIONS

MODEL	RF245-3 / RF245-5 / RF245-10
CPU	Dual 8bit Microprocessor and ISM Band Receiver
Read Range	RF245-3(3m, 10feet), RF245-5(5m, 17feet), RF245-10(10m, 34feet)
Reading Time	250ns
Frequency	2.402GHz, ISM Band
Modulation	Encrypted GFSK
Directivity	90°, One-directional / 360°, Omni-directional(optional/Suitable for access control and personnel tracking)
Receiver Gain	Better than -80dBm
Power / Current	DC12V / Max.50mA
Output Format	26bit Wiegand and RS232, Bargate Output
RS232 Format	9600bps, parity none, 8 Data bits, 1 Stop bit
Bargate Output	Low Active Pulse (1sec.), Open Collector Output, Max.100mA
OTR (One Time Reading) Input	Low Active Input, DC12V, Max, 50mA Current Drain
HOLD Input	Low Active Input, DC12V, Max. 50mA Current Drain, Vehicle Detector Input
LED Indicator	Built-in Red Color LED
Beeper	Built-in Piezo Buzzer
Operating Temperature	-35° C to +65° C (-31° F to +149° F)
Operating Humidity	10% to 90% relative humidity non-condensing
Color / Material	Ivory / Polycarbonate / Anodized Aluminum
Dimension (W x H x T)	7.9" x 7.9" x 1.8" (200mm x 200mm x 45mm)
Weight	1.36kg (3.0 lbs) excluding Mounting Bracket