

DS-2CD4635FWD-IZ(H)(S) 3MP Smart IP Vandal-proof Bullet Camera



The 3MP series Smart cameras are able to capture high quality colored images. DS-2CD4635FWD offers Full HD resolution with up to 45fps high frame rate, 120dB WDR, Defog, 3D DNR and complete Smart Feature-set to meet a wide variety of applications.

smart IPC

DS-2CD4635FWD-IZ(H)(S) is Hikvision Smart IPC and features complete Smart functions including:

Smart Detection

Intrusion Detection, Line Crossing Detection, Object Left/Removal, Area Entering/Leaving, Scene Change Detection, Audio Surge Detection, Audio Loss Detection, Defocus Detection, Face Detection, Object Counting, etc.

Smart Codec

Smart Recording with dual-VCA, Low Bitrate, Low Latency, ROI enhancement, Multi-stream, Rotate Mode, Edge Recording, etc.

Smart Image Control

Support distortion correction

- 1/2.8" Progressive Scan CMOS
- 3MP @45fps frame rate
- Slow shutter
- 120dB WDR
- 3D DNR
- -H: Heater
- -S: Audio/Alarm IO
- Support 128G on-board storage
- AC24V/PoE



Key Features

Smart

- 6 behavior analysis, 4 exception detections, 1 recognition, 1 statistic function.
- Smart recording: Support edge recording and dual-VCA.
- Smart encoding: Support low bit rate; low latency; ROI enhance encoding
- Smart lens options: AF lens

Image

- HD 2048×1536@45fps
- Supports image distortion correction
- Support rotate mode, suitable for environment as corridor.
- Support regional cropping, details can be seen with low bandwidth.
- Code smoothness setting for different requirements of image quality and fluency.
- Support H.264+/H.264/MJPEG video compression, multi-level video quality configuration; support Basic/Main/High Profile H.264 encoding complexity.
- Multiple OSD color: Black & white self-adaptive; Custom
- 120dB WDR is supportable for backlight environment.
- Support defog, BLC, HLC.

Infrared

- Irradiation distance is up to 50m(2.8-12mm)/120m(8-32mm)
- Smart IR, prevent over-exposure in close distance

System

- Support ONVIF (profile S/profile G), CGI, PSIA, ISAPI protocol.
- Support three streams, and Support 20 channels live view at the same time.
- AF automatic fast focus, maintain focused during zooming
- Smart heater for starting in extra low temperature (-H optional)
- Anti-surge, anti-static, IP66 & IK10 protection level.

Interface

- Support standard 128G Micro SD/SDHC/SDXC card storage.
- Support 10M/100M/1000M Ethernet Port.
- Support Audio I/O (-S), support dual channel stereo audio.
- Support Alarm I/O (-S)

Security

- Support three-level user authentication management, user and password authorization, IP address filtering and anonymous access.
- Support security certificate as HTTPS, SSH; support creating certificate.
- Basic and digest authentication is supportable in IE configuration
- Lock user IP for many times error login

DS-2CD4635FWD-IZ(H)(S) 3MP Smart Network Bullet Camera



Specification

Camera	
Image Sensor	1/2.8" Progressive Scan CMOS
Min. Illumination	0.005 Lux @(F1.2,AGC ON), 0.007 Lux @(F1.4,AGC ON), 0 Lux with IR
Shutter Speed	1s ~ 1/100,000s
Slow Shutter	Support
Lens	2.8-12mm @ F1.4, angle of view: 105~32°, 8-32mm @ F1.4, angle of view: 29.7°~9.7°
Auto-iris	DC drive
Day & Night	IR cut filter with auto switch
WDR	120dB
Compression Standard	
Video Compression	H.264+/H.264/ MJPEG
H.264 Type	Baseline Profile / Main Profile / High Profile
Video Bit Rate	32 Kbps – 16 Mbps
Audio Compression(-S)	G.711/G.722.1/G.726/MP2L2
Audio Bit Rate(-S)	64Kbps(G.711) / 16Kbps(G.722.1) / 16Kbps(G.726) / 32-128Kbps(MP2L2)
Image	
Max. Resolution	2048×1536
Frame Rate	50Hz: 45fps(2048 × 1536), 50fps@(1920 × 1080, 1280 × 720) 60Hz: 45fps(2048 × 1536), 60fps@(1920 × 1080, 1280 × 720)
Third Stream	Independent with Main Stream and Sub Stream, up to 50/60Hz: 10fps@1280 × 720
Image Enhancement	BLC/3D DNR/ROI/Defog
Image Setting	Rotate Mode, Saturation, Brightness, Contrast, Sharpness adjustable by client software or web browser
Regional Cropping	Support
Day/Night Switch	Auto/Schedule/Triggered by Alarm In
Picture Overlay	LOGO picture can be overlaid on video with 128x128 24bit bmp format
Network	
Network Storage	NAS (Support NFS,SMB/CIFS), ANR
Alarm Trigger	Motion detection, Tampering alarm, Network disconnect, IP address conflict, Storage exception
Protocols	TCP/IP, UDP, ICMP, HTTP, HTTPS, FTP, DHCP, DNS, DDNS, RTP, RTSP, RTCP, PPPoE, NTP, UPnP, SMTP, SNMP, IGMP, 802.1X, QoS, IPv6, Bonjour
Security	User Authentication, Watermark, IP address filtering, Anonymous access
Standard	ONVIF(PROFILE S,PROFILE G),PSIA,CGI,ISAPI
Interface	
Audio (-S)	1-ch 3.5 mm audio in (Mic in/Line in)/out interface
Communication Interface	1 RJ45 10M/100M/1000M Ethernet port, 1 RS-485 interface
Alarm (-S)	1 input, 1 output (up to DC24V 1A or AC110V 500mA)
Video Output	1Vp-p composite output (75 Ω/BNC)
On-board storage	Built-in Micro SD/SDHC/SDXC slot, up to 128 GB
Reset Button	Yes

Dimensions

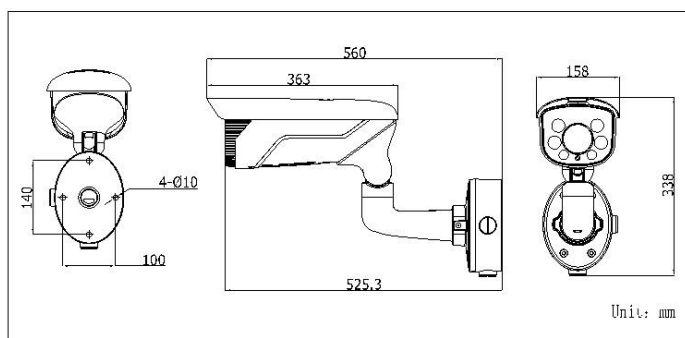

Audio (-S)

Environment Noise Filtering	Support
Audio I/O	Support dual audio track, stereo
Audio Sampling Rate	16kHz / 32kHz / 44.1kHz / 48kHz

Smart Feature-set

Behavior Analysis	Line crossing detection, Intrusion detection, Region entrance, Region exiting, Unattended baggage, Object removal
Line Crossing Detection	Cross a pre-defined virtual line
Intrusion Detection	Enter and loiter in a pre-defined virtual region
Region Entrance	Enter a pre-defined virtual region from the outside place
Region Exiting	Exit from a pre-defined virtual region
Unattended Baggage	Objects left over in the pre-defined region such as the baggage, purse, dangerous materials
Object Removal	Objects removed from the pre-defined region, such as the exhibits on display.
Exception Detections	Scene change detection, Sudden audio increase/decrease detection, Audio loss detection, Defocus detection
Recognition	Face detection recognition
Statistics	Object Counting (Entrance and Exit object number is accounted and showed on screen in real time)

General

Protection Level	IP66
Impact Protection	IK10
IR Distance	Up to 50m(2.8-12mm)/120m(8-32mm)
Operating Conditions	-30 °C – 60 °C (-22 °F – 140 °F), Humidity 95% or less (non-condensing), -H: -40 °C – 60 °C
Power Supply	24 V AC ± 10%, PoE (802.3at)
Power Consumption	24W MAX
Dimensions	158×338×560 mm (6.22" ×13.31" × 22.05")
Weight	6200 g (13.67 lbs)

Order Models

DS-2CD4635FWD-IZ, DS-2CD4635FWD-IZH, DS-2CD4635FWD-IZS, DS-2CD4635FWD-IZHS