

DS-2AF7037I

H Series IR Analog PTZ Dome Camera



Key features

IR function:

- 0 Lux minimum illumination
- Up to 150m IR distance
- IR light MTBF reaching up to 30,000 hours

System function:

- 1/3" high performance CCD
- $\pm 0.1^\circ$ Preset Accuracy
- Self-adaptive to HIKVISION, Pelco-P/D protocol
- 3D intelligent positioning function
- Power-off memory function: restore PTZ & Lens status after reboot
- Built-in temperature sensor, with display of internal temperature
- Lightning protection, surge protection and voltage transient protection
- IP66 standard
- RS-485 communication diagnosis
- Scheduled PTZ movement
- UTC(Up the Coax) function
- Smart tracking

Camera function:

- Auto focus, auto white balance, backlight compensation and auto/manual day & night switch
- Privacy masks programmable
- 3D DNR, digital zoom
- Digital WDR

PTZ function:

- 360° endless pan range and -2° - 90° tilt range
- 240°/s Pan Preset Speed and 200°/s Tilt Preset Speed
- 0.1°-160°/s Manual Pan Speed and 0.1°-120°/s Manual Tilt Speed
- 256 presets programmable; preset image freezing capability

- 8 patrols, up to 32 presets per patrol
- 4 patterns, with the total recording time not less than 10 minutes
- Proportional zoom function
- Park action: auto call up of PTZ movement, after a defined time of inactivity
- 2 alarm inputs and 2 alarm outputs(7 alarm inputs and 2 alarm outputs optional)

Application Scenarios

It can be widely applied to places requiring wide-area monitoring display, such as rivers, forests, highways, railways, airports, ports, sentries, squares, parks, scenic sites, streets, stations, large venues, outside of residential areas, etc., and the auto tracking function can be applied to the perimeter protection scenes, e.g., the perimeter of airport, harbor, and residential community.

Specifications

Parameter		Model
		DS-2AF7037I-A: PAL, 24VAC, Outdoor DS-2AF7037NI-A: NTSC, 24VAC, Outdoor DS-2AF7037I-D: PAL, 12VDC, Outdoor DS-2AF7037NI-D: NTSC, 12VDC, Outdoor H Series IR Analog PTZ Dome Camera
Camera	Image Sensor	1/3" CCD
	Effective Pixel	PAL:976(H)×582(V) NTSC:976(H)×494(V)
	Horizontal Resolution	700TVL
	Signal System	PAL /NTSC
	Min. Illumination	Color: 0.02Lux/(F1.6, AGC ON), 0.0008Lux /(F1.6, AGC ON, IRE×256) B/W: 0.002Lux/(F1.6, AGC ON), 0.00008Lux /(F1.6, AGC ON, IRE×256) 0 lux with IR
	White Balance	Auto / Manual / ATW / Indoor / Outdoor
	AGC	Auto / Manual
	S / N Ratio	≥ 50dB
	3D DNR	Support
	Backlight Compensation	Support
	Digital WDR	Support
	Shutter Time	PAL: 1/3-1/10,000s NTSC: 1/4-1/10,000s
	Day & Night	IR Cut Filter
	Digital Zoom	16x
	Privacy Mask	8 privacy masks programmable; a maximum of 8 zones can be masked simultaneously on the same video screen
Focus Model	Auto / Semiautomatic / Manual	
Lens	Focal Length	3.2-118.4mm, 37X

	Zoom Speed	Approx.3.0s(Optical Wide-Tele)
	Angle of View	58-1.7 degree(Wide-Tele)
	Min. Working Distance	10-1500mm (Wide-Tele)
	Aperture	F1.6-F4.4
Pan and Tilt	Pan Range	360° endless
	Pan Speed	Pan Manual Speed: 0.1° -160°/s, Pan Preset Speed: 240°/s
	Tilt Range	-2°-90°(Auto Flip)
	Tilt Speed	Tilt Manual Speed: 0.1°-120°/s, Tilt Preset Speed: 200°/s
	Proportional Zoom	Rotation speed can be adjusted automatically according to zoom multiples
	Number of Preset	256
	Patrol	8 patrols, up to 32 presets per patrol
	Pattern	4 patterns, with the total recording time not less than 10 minutes
	Power-off Memory	Support
	Park Action	Preset / Patrol / Pattern / Pan scan / Tilt scan / Frame Scan / Random scan / Panorama scan
	PTZ Position Display	On / Off
	Preset Freezing	Support
	Password Protection	Support
	Zone Scanning/Display	Scanning within programmed zone, display zone title
	Camera Title	Programmable title display
	Compass	Support , the north can be set
	Scheduled Task	Preset / Patrol / Pattern / Pan scan / Tilt scan / Frame Scan / Random scan / Panorama scan
	RS-485 communication diagnosis	Support
Smart tracking	Support	
Infrared	IR distance	150m
	IR Intensity	Automatically adjusted, depending on the zoom ratio
Input/ Output	Monitor Output	1.0V[p-p] / 75Ω, NTSC (or PAL) composite, BNC
	Alarm Input	2(7 alarm inputs optional)
	Alarm Output	2 relay outputs, alarm response actions configurable
	Alarm Action	Preset / Patrol / Pattern / Pan scan / Tilt scan / Random scan / Frame scan / Panorama scan / Relay output
	RS-485 Interface	Half-duplex mode Self-adaptive HIKVISION, Pelco-P, Pelco-D protocol
	UTC function	Self-adaptive PELCO_C, HIKVISION_C(need UTC controller)
General	Menu Language	English, Chinese

Power	24VAC (only for -A model); 12VDC(only for -D model) Max. 50W
Working Temperature / Humidity	-30 °C-65°C(-22°F-149°F) 90% or less
Protection Level	IP66 standard TVS 4,000V lightning protection, surge protection and voltage transient protection
Mounting	Various mounting modes optional
Dimensions	Φ245 ×399mm (Φ9.65" ×15.71")
Weight (approx.)	6kg(13.22 lbs)
Mount Option (only suitable for outdoor dome)	Long-arm wall mount: DS-1602ZJ;Corner mount: DS-1602ZJ-corner; Pole Mount: DS-1602ZJ-pole; Power box mount:DS-1602ZJ-box

Dimensions

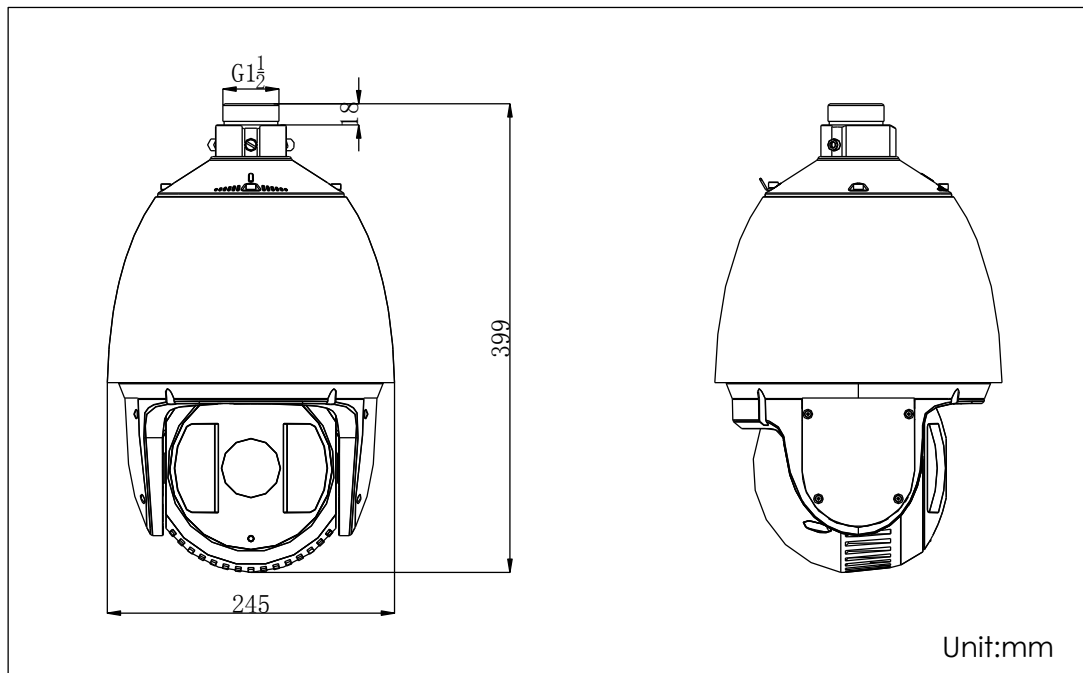

Order models

DS-2AF7037I-A: PAL, 24VAC, Outdoor

DS-2AF7037NI-A: NTSC, 24VAC, Outdoor

DS-2AF7037I-D: PAL, 12VDC, Outdoor

DS-2AF7037NI-D: NTSC, 12VDC, Outdoor

Accessories



DS-1602ZJ Long-arm Wall Mount Bracket