

IR LED Dome Camera with Built-in Vari-Focal Lens

# SIR-4250S



## Specifications

Mode	SIR-4250SN	SIR-4250SP
Power Source	12V DC (±10%)	
Power Consumption	Max. 3.6W (LED On)	
Image Pick-up Device	1/3" Super HAD CCD	
Total Pixels	811(H) x 508(V)	795(H) x 596(V)
Effective Pixels	768(H) x 494(V)	752(H) x 582(V)
Scanning System	2 : 1 Interlace	2 : 1 Interlace
	525 Lines / 60 Fields / 30 Frames	625 Lines / 50 Fields / 25 Frames
Synchronization	Internal	
Scanning Frequency	Horizontal : 15,734KHz / Vertical : 59.94Hz	Horizontal : 15,625KHz / Vertical : 50Hz
Horizontal Resolution	Color : 520TV lines (Min.) / B/W : 570TV lines (Min.)	
Video Output	1.0Vp-p / 75Ω (Video 0.714Vp-p, Sync 0.286Vp-p) 1.0Vp-p / 75Ω (Video 0.7Vp-p, Sync 0.3Vp-p)	
S / N Ratio (Y signal)	50dB (AGC off, Weight on)	
Min. Illumination	LED On	0 Lux@F1.2 (B/W mode, 50IRE)
	LED Off	0.7Lux@F1.2 (Normal color mode, 50IRE) 0.005Lux@F1.2 (Sens-up mode, 50IRE)
Lens	2.5X Auto iris varifocal lens (F1.2, 3.8 ~ 9.5mm)	
IR LED	10ea (Black)	
IR Distance	16m	
Back Light Compensation	Low / Middle / High / Off	
Day & Night	Color / B/W / Auto (ICR filter change)	
Gain Control	Normal / High / Off	
White Balance	ATW / AWC / Manual (1,800°K ~ 10,500°K)	
Electronic Shutter Speed	Fixed (1/60 / Flickerless)	Fixed (1/50 / Flickerless)
Sens-up (Frame Integration)	On / Off (Selectable limit ~ 128X)	
OSD	Built-in	
SSNR	Low / Middle / High / Off	
Motion Detection	On / Off	
Privacy Function	On / Off selectable (4 Programmable zones)	
Mirror	On / Off	
Sharpness	On / Off selectable (Level adjustable)	
Communication	RS-485 (Pelco-D)	
Iris Control	DC fixed	
Operating Temperature	-10°C ~ +50°C	
Operating Humidity	30% ~ 80% RH	
Dimensions	Ø145.3(W) x 109.5 (H)mm / Ø5.72"(W) x 4.31"(H)	
Weight	985g (2.17 lb)	

## Dimensions

Unit : mm (inch)

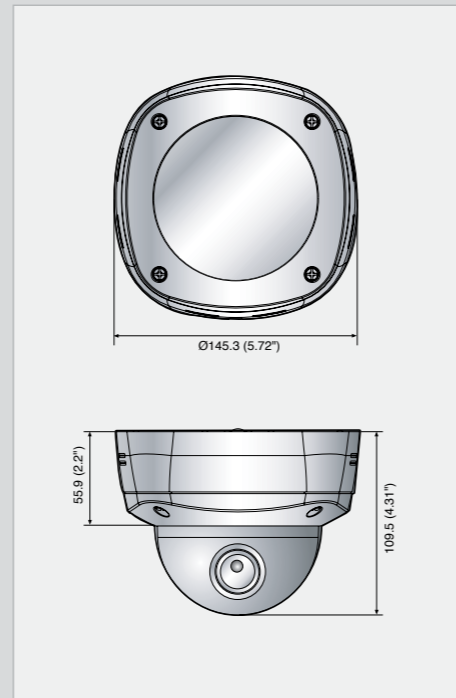

Eyes that Light up in  
Total Darkness

High-performance IR LED Dome Camera

# SIR-4250S



The Eco mark represents Samsung Techwin's will to create environment-friendly products, and indicates that the product satisfies the EU RoHS Directive.

Design and specifications are subject to change without notice.



**SAMSUNG TECHWIN CO., LTD.**  
145-3, Sangdaewon 1-dong, Jungwon-gu, Seongnam-si, Gyeonggi-do Korea 462-703  
Tel : +82-31-740-8151 ~ 8 Fax : +82-31-740-8145  
www.samsungcctv.com

**SAMSUNG OPTO-ELECTRONICS AMERICA, LTD.**  
1480 Charles Willard St. Carson, CA 90746  
Tel : +1-310-632-1234 Fax : +1-310-632-2195

**SAMSUNG OPTO-ELECTRONICS UK, LTD.**  
Samsung House, 1000 Hillwood Drive,  
Hillwood Business Park Chertsey, Surrey KT16 0PS  
Tel : +44-1932-455312 Fax : +44-1932-455325

**TIANJIN SAMSUNG OPTO-ELECTRONICS CO., LTD.**  
7 Pingchang Rd., Nankai Dist. Tianjin 300190, P.R. China  
Tel : +86-22-2761-4724(3821) Fax : +86-22-2761-6514

■ DISTRIBUTED BY



I.D-0805

imagine the ultimate night surveillance

The SIR-4250S is a high-performance IR LED dome camera with various features for advanced functions such as high-resolution video images, ICR Day & Night feature, Vari-Focal Lens and SSNR, unique noise reduction technology, which ensures you have the most reliable 24-hours a day video surveillance providing clean and vivid images for all places.



**SAMSUNG TECHWIN**



No More Total Darkness!  
**0Lux** Minimum Illumination!

High-performance IR LED Dome Camera

# SIR-4250S

Up to 4 Times More Powerful **IR LEDs** Integrated!  
 The Perfect 24-hour Security Solution

High-performance **IR LEDs** ensures ultimate night viewing

**Vari-focal lens** provides a more flexible surveillance environment

**Day & Night (ICR type)** feature offers round-the-clock monitoring

Discrete video security with its **Smoke Dome Cover**



The SIR-4250S provides high-resolution video images regardless of day or night, and it can detect and distinguish a moving subject in a pitch-dark environment with 0 Lux minimum illumination.



## 0 Lux Minimum illumination that monitors in total darkness!

The SIR-4250S can visualize even the small movement of subjects in total darkness without any light. It can be trusted to deliver the most reliable video surveillance at an incredible low light level of 0 Lux with high performance IR LED illuminators.

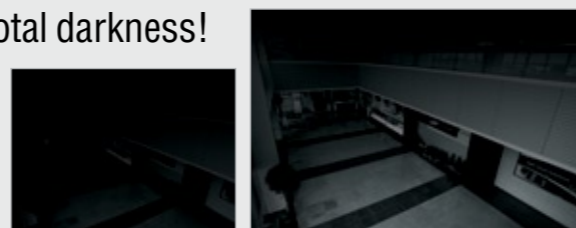

Conventional Camera

SIR-4250S



## High Performance IR LEDs ensure 4 times higher brightness

The SIR-4250S incorporates high performance IR LED lamps that provide up to 4 times higher brightness than standard LEDs for clearer images in complete darkness. The illuminators withstand high temperature of up to 100°C and consume less power ensuring a longer life span of cameras.

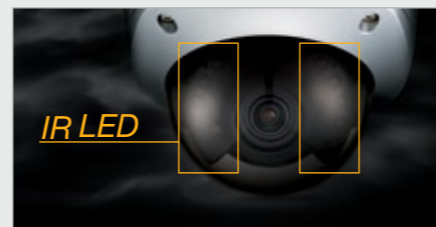

## Vari-Focal Lens (3.8 ~ 9.5mm) for a more flexible surveillance

The SIR-4250S is equipped with a vari-Focal Lens of 3.8 ~ 9.5mm that ensures optimum video image and focus setting so that users get the best view at a variety of surveillance environments.

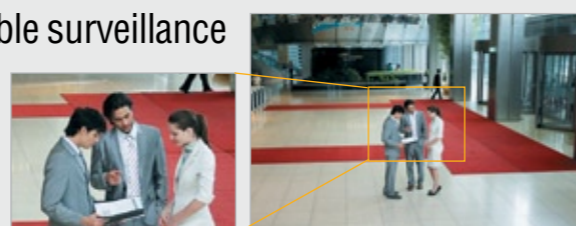

2.5X zoom



## Day & Night (ICR type) feature for around the clock surveillance

The SIR-4250S produces optimum image quality at night by automatically removing the filters with its Day & Night feature (ICR type). It automatically switches either to vivid color images during the day or a high resolution of over 570TV lines in black and white during the night.



Day

Night

## High resolution of 520TV lines for clearer images

The SIR-4250S, with its high-performance CCD image sensor and DSP chip, gives users a high resolution of 520TV lines. The lines and colors of the subject are clear and vivid, making it easier to distinguish the subject being monitored.

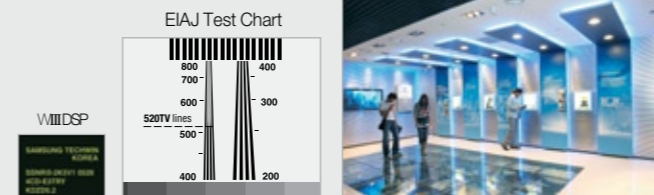

## IR MODE for Clear Subject Recognition

The SIR-4250S provides IR Mode function that prevents short distance saturation when IR LEDs are lighted, resulting in clear recognition of a subject located within 3 meters.



Conventional Camera

SIR-4250S

## SSNR provides vivid images with less DVR capacity

The SIR-4250S applies Samsung Techwin's world-renown noise reduction technology SSNR to eliminate any noise or after image associated with night environments, which can give the additional benefit of reducing the video file size to substantially reduce the DVR capacity by up to 70%.

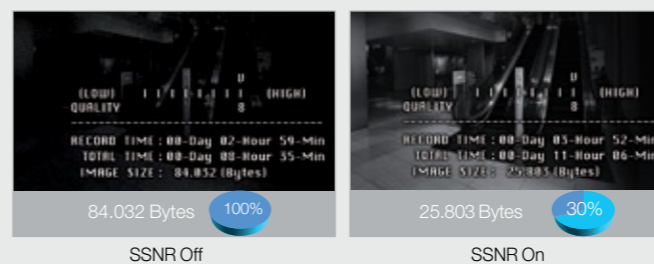

SSNR Off

SSNR On

## Privacy Masking & Wide Range White Balance

The SIR-4250S's Privacy Masking feature can easily create a "mask" over up to 4 areas that are sensitive in terms of surveillance. It also automatically covers a color temperature range from 1,800°K to 10,500°K for optimum colors, even when used in poor conditions, for example in interior sodium lighting.

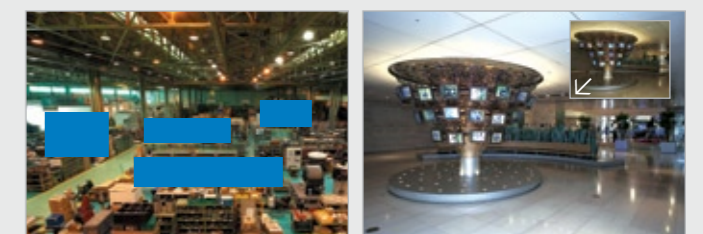

Privacy Masking

White Balance

## 3-Axis rotating dome mechanism & Additional service monitoring output

The SIR-4250S dome base rotates and shifts horizontally or vertically so users can position the camera to get the exact pictures needed. Installation is made simpler by a service video connector that provides the installer with easy access to the assistant video from the camera.

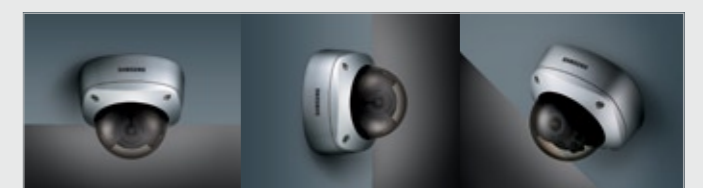

Ceiling

wall

Slope