







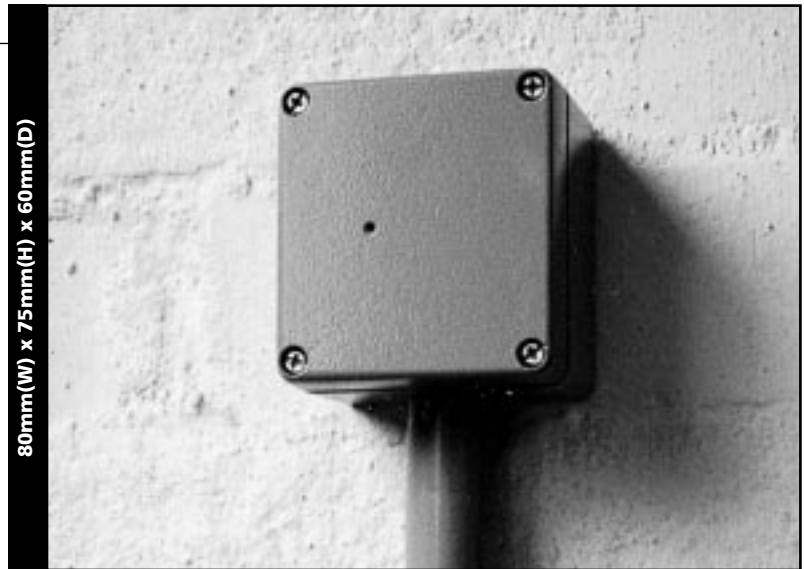
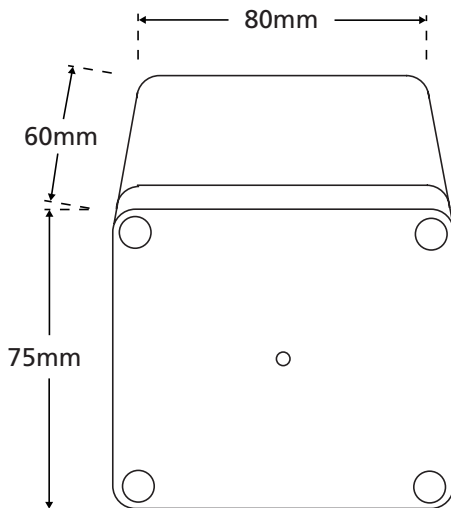

COVERT CAMERA

COLOUR

JB-650/PA

● Junction box colour camera



-  1/4" CCD
-  350 TV lines
-  10.0 lux sensitivity
-  Supply voltage: 12 Vdc
-  Audio output: 1V p-p

Lens option

| Lens | Product Code |
|---------------|--------------|
| 3.6mm pinhole | JB-650/PA |

- Tough, die-cast aluminium housing
- A very popular and effective covert camera
- Blends into many industrial or commercial environments
- Comes with free power supply
- Comes with free audio capability
- Comes with lint-free cleaning cloth to remove grease and dirt from case and lens

See Also:



JB-350/PA
Monochrome
option



TH-350/PA
Thermostat
monochrome
camera



PI-350/A
PIR case
monochrome
camera

| SPECIFICATION | | MOD-607/P camera module |
|---------------------|-----------------------|---|
| VIDEO | Image sensor | 1/4" CCD sensor, 500 (H) x 582 (V) pixels |
| | Horizontal resolution | 350 TV lines or greater |
| | Lens options | SEE TABLE |
| | Electronic shutter | Automatic linear shutter |
| | Sensitivity | 10.0 lux |
| | Video output | PAL, 1Vp-p, 75 Ohms |
| | Supply voltage | 12 Vdc ± 10% |
| Working temperature | -5°C to +40°C | |
| AUDIO | Microphone | Omni-directional electret |
| | Audio output | 1Vp-p, 600 Ohms |
| | Audio bandwidth | 100Hz - 10KHz, +/- 3dB |

Specification and availability of products are subject to change without notice