



**DISCREET CAMERA**

**COLOUR**

# CW-610VR



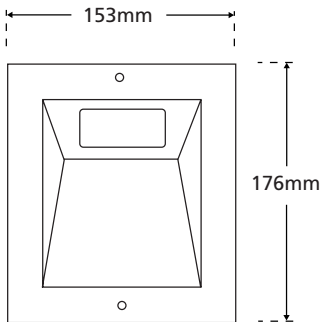

- Outdoor vandal-resistant colour ceiling/wall mount camera

View from front

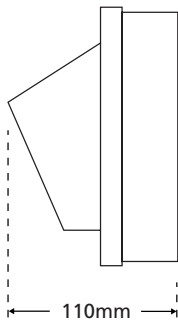

Side view



-  1/3" CCD
-  330 TV lines
-  2.5 lux sensitivity
-  Supply voltage: 12 Vdc

**Lens options**

Lens	Product Code
4.0mm	CW-610VR
2.3mm	CW-610VR/2.3
5.6mm	CW-610VR/5.6
8.0mm	CW-610VR/8.0
16.0mm	CW-610VR/16.0

All lens options are the same price

- Superb picture quality
- Beige, powder-coated, 1.5mm stainless steel housing designed to IP65
- Easily replaceable, toughened, 4mm thick, polycarbonate viewing window
- Smoked viewing window also available - product code: VR-WGR
- Tamper-proof upgrade kit available - product code: VR-TRK
- Camera module mounted on manually adjustable miniature 'swivel and tilt' cradle, for exact camera positioning
- Comes with built-in 220Vac heater and thermostat to prevent misting
- Two conduit knockouts to enable vandal-resistant cabling

*"These units are small, can withstand a very high level of abuse and we would recommend their use"*

PSI Magazine Bench Test - October 1998

See Also:



**CW-310VR**  
Monochrome option

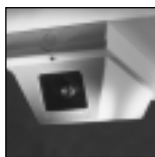

**CW-610VR/AI**  
Auto-iris colour option



**CW-710VR**  
High resolution colour option

**VIDEO**

SPECIFICATION	MOD-616 camera module
Image sensor	1/3" CCD sensor, 500 (H) x 582 (V) pixels
Horizontal resolution	330 TV lines or greater
Lens options	SEE TABLE
Electronic shutter	Automatic linear shutter
Sensitivity	2.5 lux
Video output	PAL, 1Vp-p, 75 Ohms
Supply voltage	12 Vdc ± 10%
Working temperature	-5°C to +40°C

Specification and availability of products are subject to change without notice