



FH 7519 E – 19" TFT monitor

Specifications

LCD Display: 19" SXGA TFT LCD panel
Viewable size: 376,3 (H) x 301,06 (V) mm / 5:4
Contrast ratio: 500:1 (typ.)
Brightness: 300 cd / m² (typ.)
Response time (tr/ta): 8 ms (typ.)
Display colour: 16,7 million
Pixel pitch: 0,297 (H) x 0,297 (V) mm
Max. resolution: 1280 x 1024
Horizontal frequency: 31 K ~ 80 KHz
Vertical frequency: 56 Hz ~ 75 Hz
Viewing angle H/V: 160° / 150°
Video inputs: 2 x FBAS Video 1,0 Vp-p, BNC, Ch. 2 with loop-through / automatic 75 Ohm termination
 S-Video, mini DIN
 VGA, 15-pin D-Sub

Audio: 2 x line in Cinch / line out 3,5mm stereo jack,
 2 internal speakers 2,5W (max.)

OSD menu: all modes: colour, brightness, contrast,
 H-Pos., V-Pos., V-size, H-size, clock, phase, colour temp.
 user colour R/G/B, OSD H-Pos. / V-Pos., volume,
 language (EN/DE/FR/TR/IT/ES/CN), load default

Power input: 12 VDC / 3A,
 via external power supply 100~240 VAC

Power consumption: 35W (max.), 5W in power saving mode
Power management: VESA DPMS, DDC1 / 2B compatible

Operating condition: Temp. 0°C ~ +40°C, humidity 10~85%
Storage condition: Temp. -20°C ~ +60°C, humidity 10~85%
Dimensions: 420 (W) x 360 (H) x 60 (D) mm (w/o stand base)
Weight: 6,0 kg
Approvals: FCC, CE, UL, RoHS
Mounting: stand base included,
 VESA compatible mount 75x75

Mounting accessories: BA DW 151 / 161 (wall / table mount)
 BA DW 170 / 171 (wall mount)
 BA DW CM (ceiling mount with BA DW 170 / 171)
 BA DW CM2 (ceiling mount)

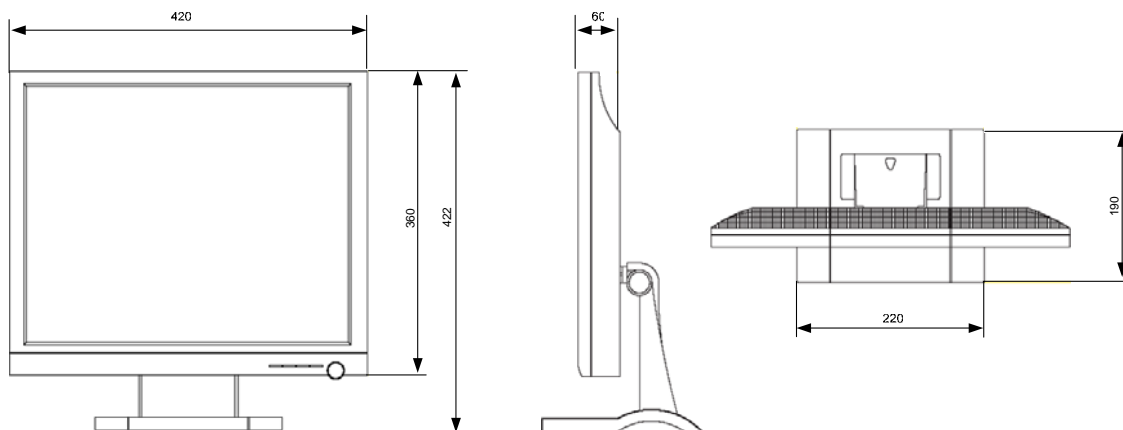

FH7519E_db_en_rev01