



## FH 7517 EA – 17" TFT monitor, HD-ready

### Specifications

**LCD Display:** 17" active matrix TFT LCD panel

**Viewable size:** 338 (H) x 270 (V) mm / 5:4

**Contrast ratio:** 800:1 (typ.)

**Brightness:** 300 cd / m<sup>2</sup> (typ.)

**Response time (tr/ta):** 5 ms (typ.)

**Display colour:** 16,7 million

**Pixel pitch:** 0,264 (H) x 0,264 (V) mm

**Max. resolution:** 1280 x 1024

**Horizontal frequency:** 31 K ~ 80 KHz

**Vertical frequency:** 56 Hz ~ 75 Hz

**Viewing angle H/V:** 160° / 140°

**Video inputs:** 2 x FBAS Video 1,0 Vp-p, BNC, with loop-through / automatic 75 Ohm termination

S-Video, mini DIN

VGA, 15-pin D-Sub

1 x HDMI

**Audio:** 2 x line in Cinch / line out 3,5mm stereo jack,  
2 internal speakers 2,5W (max.)

**OSD menu:** all modes: colour, brightness, contrast, H-Pos., V-Pos., V-size, H-size, clock, phase, colour temp. user colour R/G/B, OSD H-Pos. / V-Pos., volume, language (EN/DE/FR/IT/ES), load default

**Power input:** 12 VDC / 3A,  
via external power supply 100~240 VAC

**Power consumption:** 35W (max.), 5W in power saving mode

**Power management:** VESA DPMS, DDC1 / 2B compatible

**Operating condition:** Temp. 0°C ~ +40°C, humidity 10~85%

**Storage condition:** Temp. -20°C ~ +60°C, humidity 10~85%

**Dimensions:** 374 (W) x 327 (H) x 54 (D) mm (w/o stand base)

**Weight:** 5,8 kg

**Mounting:** stand base included,  
VESA compatible mount 75x75

**Mounting accessories:** BA DW 151 / 161 (wall / table mount)

BA DW 170 / 171 (wall mount)

BA DW CM (ceiling mount with BA DW 170 / 171)

BA DW CM2 (ceiling mount)

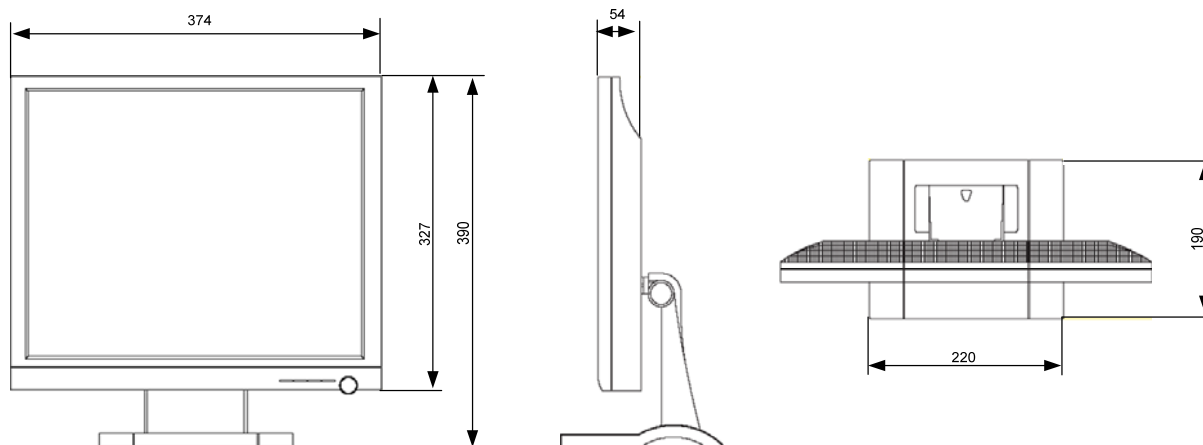

FH7517EA\_db\_en\_rev00