



## GXC-1605M

Article-No.: 92706

1/3" Network Camera,  
Day&Night, CMOS, H.264, MPEG4,  
1280x1024, PoE, ONVIF

### Mainfeatures

1/3" Sony 1.3 megapixel CMOS sensor  
Simultaneous video streaming (H.264/MJPEG/MPEG-4)  
WDR (Wide Dynamic Range)  
Integrated motion detection  
Alarm-recording (Micro SD card/SDHC)  
Privacy zone masking

Resolution max. 1280 x 1024 (HD 720p) max.  
Removeable IR cut filter (ICR)  
ROI (Region of Interest)  
Audio and alarm in-/outputs  
ONVIF conformity  
Client management software included

### Specifications

Series	eneo GL
Resolution standard	HD 720p
System	day&night
Video standard	CCIR/PAL
Sensor size	1/3"
Imager	CMOS
Imager	Sony IMX035
Sensitivity (at 50% video signal)	0,2 Lux
Sensitivity (at 50% video signal)	at F1.2
Digital signal processing (DSP)	TI TMS320DM355 (digital media processor)
Synchronization	internal
Automatic gain control (AGC)	8x / 16x / 32x / 64x
Automatic electronic shutter (ESC)	ON/OFF switchable
Manual electronic shutter (MES)	1/2sec. ~ 1/2,000sec.
Digital Noise Reduction (DNR)	yes
Low speed shutter	yes





## Specifications (continued)

White balance	AWB, Indoor / Outdoor switchable
Wide Dynamic Range (WDR)	yes, 9 levels
Flickerless function	yes
IR cut filter	switchable
Mirror function	horizontal, vertical
Privacy zones masking	3 zones masking, ON/OFF switchable
Activity detection	yes
Motion detector	512 zones (0-100%)
Text display	IP Address / Date / Time / Icon
Menu languages	German, English, French, Spanish, Italian, Portugese, Dutch, Polish, Czech, Swedish, Finnish, Hungarian, Romanian, Turkish, Chinese
OSD function control	AGC, AWB, exposure, ESC, H/V flip (mirror picture), brightness, text, colour intensity, motion detection, contrast, WDR, resolution, language
External adjustments	IP protocol stat./dyn., ESC / DC iris lens, reset
External connections	video (BNC), network (RJ-45), audio & alarm inputs/outputs, DC Iris (4 pin), USB, RS-485, power inputs
Video outputs	composite (CVBS)
Video outputs	1Vp-p, 75ohms, BNC
Audio support	yes
Audio	1/1 Line input and output, Built-in Microphone
Alarm inputs	1
Alarm outputs	1
Alarm handling	via FTP, HTTP or SMTP. External output activation. SD/SDHC card recording, CMS S/W recording
Internal storage	SD card, SDHC card
Compression standard	H.264, MPEG-4, MJPEG
Resolution max.	1280 x 1024
Resolution	1280x1024 (SXGA), 1280x720 (HD 720), 640x480 (VGA), 320x240 (XVGA), 160x120 (QQVGA)
Image transmission rate max.	25 B./Sek.
Frame rate	25 fps max. at 1280x1024 px. (H.264)
Bandwidth	controllable bandwidth and frame rate
Stream types	H.264, MPEG-4, MJPEG multiple
Image display	via Web Browser or Viewer Software
Ethernet interface	10Base-T, 100Base-TX
Web browser	MS Internet Explorer vers. 7.0 or higher, Google Chrome (Java), Mozilla Firefox (Java), Safari (Java)
Network protocols	IPv4, ARP, TCP/IP, UTP, ICMP, DHCP, HTTP, HTTPS, RTP, RTCP, RTSP, 3GPP, NTP, DNS, DDNS, PPPoE, UPnP, SAMBA, FTP, SMTP
Remote configuration	remote software
Lens mount	CS mount
Digital zoom	yes, 1x ~ 10x
Pre-alarm recording	up to 9sec.
PTZ support	yes
Search function	alarm/event/time searching
Serial interfaces	RS-485



## Specifications (continued)

Serial interfaces	Protocols: Pelco P & D
Access	10 users simultaneous support
Firmware update	SD card / HTTP (Web browser)
Password protection	yes
Management Software Support	CMS software
SDK	available, SDK incl. HTTP-API and ActiveX
ONVIF	core specifications 1.01
Power consumption	2.5W
Temperature range (operation)	0°C ~ +50°C
Supply voltage	12VDC, 24VAC, PoE (IEEE-802.3af)
Power over Ethernet	yes
Protection rating	n/a
Certificates	CE, ONVIF
Parts supplied	camera, PSU 100~240VAC, manual, USB connection cable, installation CD
Weight	400g
Dimensions (HxWxD)	56x68x114.8mm
Remarks	free bundle recording software, SDK incl. HTTP-API and ActiveX available,
Special features	installation wizard via web browser

## Optional Accessories

Image	Artikel-Nr. / Typ	Description
	WD-22	Wall Mount Bracket with Ball Joint, 1/4" Camera Fixing Screw, Beige Grey
	WD-23	Wall Mount Bracket with Ball Joint, 1/4" Camera Fixing Screw, Pantone 877
	F03Z2.710NDDCMP	F1.0/3-8mm Megapixel DC Lens with variable Focal Length, 1/3" CS Mount
	F05Z10NDDC-MP	F1.4/5-50mm Megapixel DC Lens with variable Focal Length, 1/3" CS Mount

## Optional Accessories (continued)

Image	Artikel-Nr. / Typ	Description
	NE-132/AC24V	Power Supply Unit 230VAC/24VAC (1.0A)
	GL CMS-MANAGER	Viewer and Control Software for eneo Network Series GL, MJPEG, MPEG4, H.264
	POE20U-560(G)	High PoE Midspan, 1 Port, 19.6W, Gigabit, 100-240VAC
	POE125U-8C	PoE Midspan, 8 Ports, 15.4W, Gigabit, 100-240VAC

## Technical Drawing

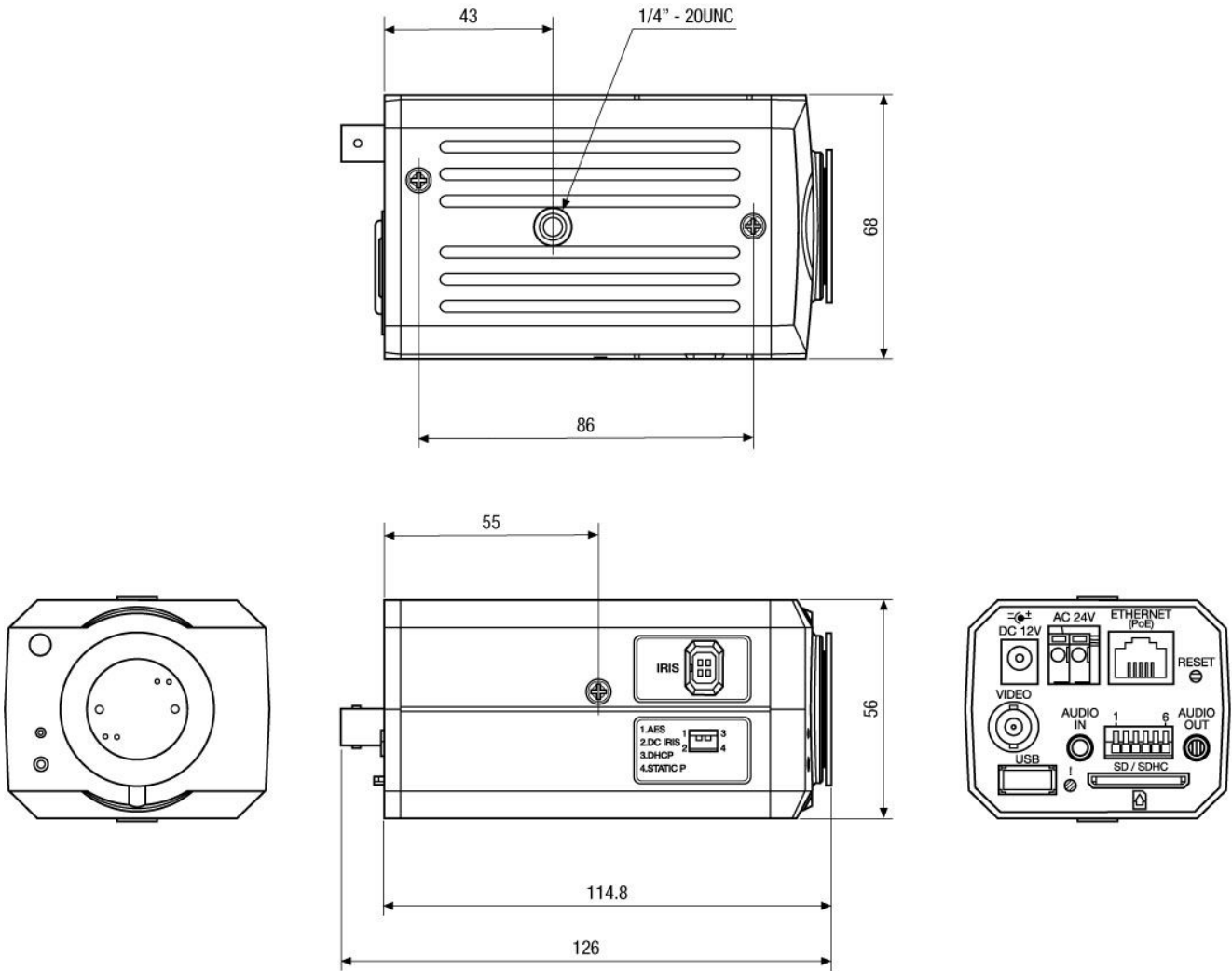

Maße/Dimensions: mm

Your partner for eneo products:

