



## GXC-1604M

Article-No.: 92583

1/3" Network Camera, CMOS, Day&Night,  
1280x960, MPEG-4, MJPEG, PoE, ONVIF

### Mainfeatures

1/3" Sony 1.3 Megapixel CMOS sensor  
Removal IR cut filter (ICR)  
Supports privacy zones masking  
On-screen display (OSD)  
Simultaneous MJPEG & MPEG-4 video streaming

Sensitivity of 0.15Lux at F1.2 (Colour)  
Integrated activity detection / Alarm in&output  
Equips two-way audio / Built-in microphone  
3GPP Mobile surveillance  
Controllable bandwidth and frame rate

### Specifications

Series	eneo GL
System	day&night
Video standard	CCIR/PAL
Sensor size	1/3"
Imager	CMOS
Imager	Sony IMX035
Sensitivity (at 50% video signal)	0,15 Lux
Sensitivity (at 50% video signal)	at F1.2 (measured)
Digital signal processing (DSP)	TI TMS320DM355 (digital media processor)
Automatic gain control (AGC)	ON/OFF switchable
Automatic electronic shutter (ESC)	ON/OFF switchable
Digital Noise Reduction (DNR)	no
Low speed shutter	yes
Low speed shutter	2 ~ 64 Fps., ON /OFF switchable
White balance	AWB, Indoor / Outdoor switchable
Wide Dynamic Range (WDR)	yes
Backlight compensation	BLC





## Specifications (continued)

Flickerless function	yes
IR cut filter	switchable
Mirror function	horizontal, vertical
Privacy zones masking	ON/OFF switchable
Activity detection	yes
Motion detector	96 areas, 5 levels
Text display	11 character labels, ON/OFF switchable
Menu languages	English
OSD function control	H/V flip (Mirror picture), Contrast, Sharpness & Brightness correction, Exposure, AGC, AWB, BLC, Motion detection, Privacy zones masking, Day&Night (automatic / manual), Text, Image size and bit rate
External adjustments	IP protocol stat./dyn., ESC / DC iris lens
External connections	Video (BNC), Network (RJ-45), Audio & Alarm Inputs/Outputs, DC Iris (4 pin), USB, RS-485, Power inputs
Video outputs	composite (CVBS)
Video outputs	1Vp-p, 75ohms, BNC
Audio support	yes
Audio	1/1 Line input and output, Built-in Microphone
Alarm inputs	1
Alarm inputs	1
Alarm outputs	1
Alarm handling	via FTP, HTTP or SMTP. External output activation. SD/SDHC card recording, CMS S/W recording
Internal storage	SD card
Compression standard	MJPEG, MPEG-4
Resolution max.	1280 x 960
Resolution	1280x960, 1280x720, 640x480, 320x240, 160x120
Image transmission rate max.	25 B./Sek.
Frame rate	25 Fps. max. at 1280x960 px.
Bandwidth	Controllable bandwidth and frame rate
Stream types	MPEG-4, MJPEG multiple
Image display	Via Web Browser or Viewer Software
Ethernet interface	10Base-T, 100Base-TX
Web browser	MS Internet Explorer vers. 7.0 min., , , ,
Network protocols	IPv4, ARP, SMTP, ICMP, DNS, DDNS, HTTP, HTTPS, FTP, DHCP, UPnP, RTSP, RTP, RTCP, TCP, UDP, PPPoE
Remote configuration	via Remote Software
Lens mount	CS mount
Digital zoom	2x - 10x
Pre-alarm recording	up to 4sec.
PTZ support	yes
Search function	Alarm/Event/Time searching
Serial interfaces	RS-485
Serial interfaces	Protocols: Pelco P & D
Access	16 Users simultaneous support
Software update	SD card / HTTP (Web browser)
Password protection	yes
Management Software Support	CMS Software





## Specifications (continued)

SDK	available, SDK incl. HTTP-API and ActiveX
ONVIF	version 1.01
Power consumption	2.5W
Temperature range (operation)	0°C ~ +50°C
Colour	Pantone Cool Gray 1C
Supply voltage	12VDC, 24VAC, PoE
Power over Ethernet	yes
Protection rating	n/a
Certificates	CE
Parts supplied	PSU 100~240V/12VDC with power cord, USB cable, C/CS adapter ring, CMS software, manual
Weight	400g
Dimensions (HxWxD)	see drawing
Remarks	Free bundle recording software, SDK incl. HTTP-API and ActiveX available

## Optional Accessories

Image	Artikel-Nr. / Typ	Description
	NE-132/AC24V	Power Supply Unit 230VAC/24VAC (1.0A)
	WD-22	Wall Mount Bracket with Ball Joint, 1/4" Camera Fixing Screw, Beige Grey
	WD-23	Wall Mount Bracket with Ball Joint, 1/4" Camera Fixing Screw, Pantone 877
	WD-13-WA	Ceiling Mount with Ball Joint, 1/4" Camera Fixing Screw, RAL9006

## Optional Accessories (continued)

Image	Artikel-Nr. / Typ	Description
	VTL-300/WW-POEB	Weatherproof Housing, 300mm, Wall Bracket, Heater, Fan, 12V, RJ-45, PoE
	GL CMS-MANAGER	Viewer and Control Software for eneo Network Series GL, MJPEG, MPEG4, H.264
	F05Z10NDDC-MP	F1.4/5-50mm Megapixel DC Lens with variable Focal Length, 1/3" CS Mount
	F03Z2.710NDDCMP	F1.0/3-8mm Megapixel DC Lens with variable Focal Length, 1/3" CS Mount

## Technical Drawing

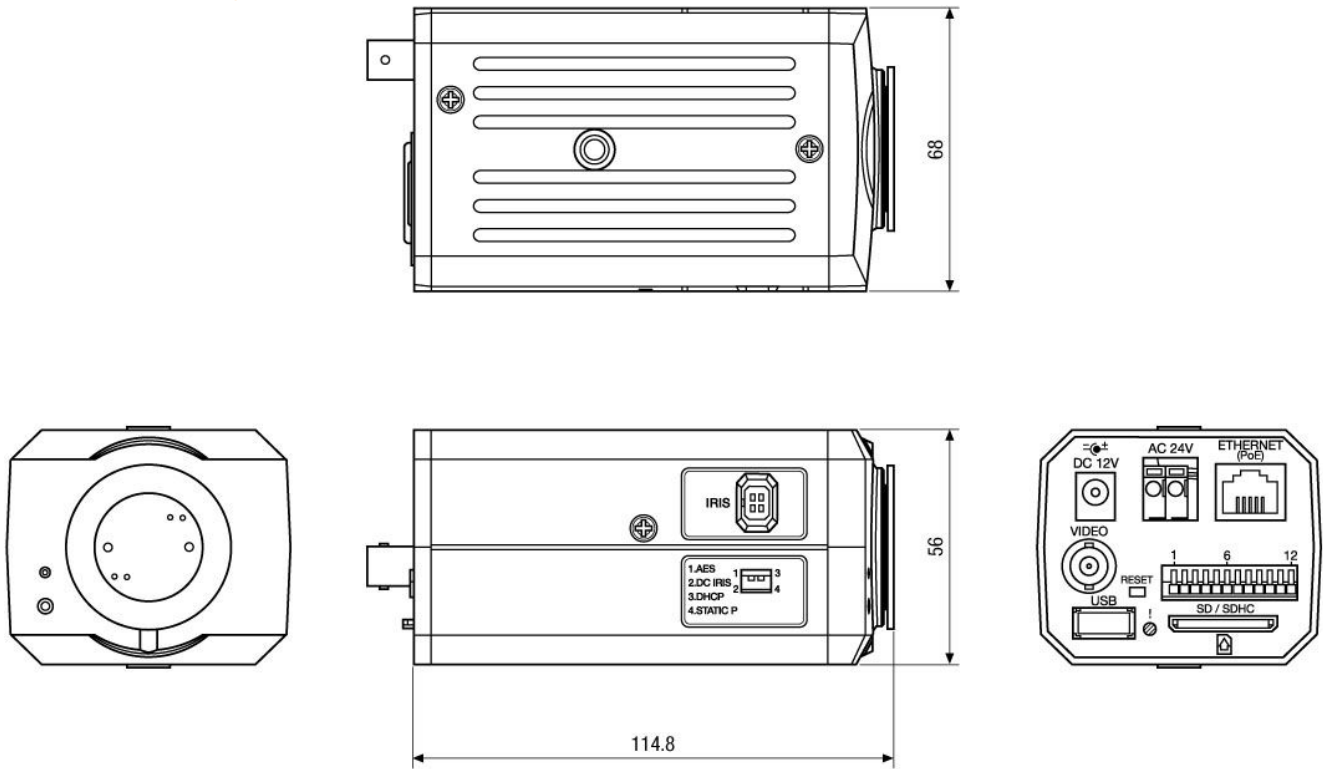

Maße/Dimensions: mm

Your partner for eneo products:

