

Video Security



G0608NDAI-560

F0.8/6mm Aspherical AI Lens, F560,
1/2" CS Mount

Art-No. 43234



Features

Suitable for 1/2" and 1/3" Colour and B&W Cameras
High Standard of Optical and Mechanical Quality
Aspherical Lens Elements

Built-in Auto Iris Amplifier
Adjustable Slip-ring Mount for Cable Positioning
CS Mount

Specifications

Focal length (f)	6.0mm
Aperture range (F)	0.8-560
Lens mount	CS
Nominal format size	1/2"
Flange focal length	12.5mm
Horizontal angle of view at nominal format size	56.7°
Minimum object distance (M.O.D.)	0.25m
Screw-in depth	B&W: 7.5mm / Colour: 3.5mm
Filter screw size	M40.5x0.5mm
Slip-ring mount	340°-360° Variable adjustment range
Iris control system	Galvanometer
Input signal range	0.5 to 1.0Vp-p (C)CVS
Response time	<2sec.
Accuracy at +20°C	+/-15%
Max. current consumption	35mA
Cable length	350mm
Dimensions (LxDxH)	See drawing
Temperature range	-20°C to +50°C
Weight	150g

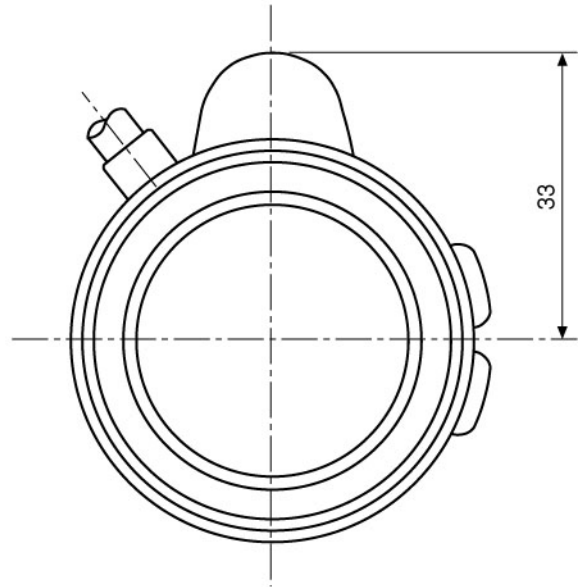
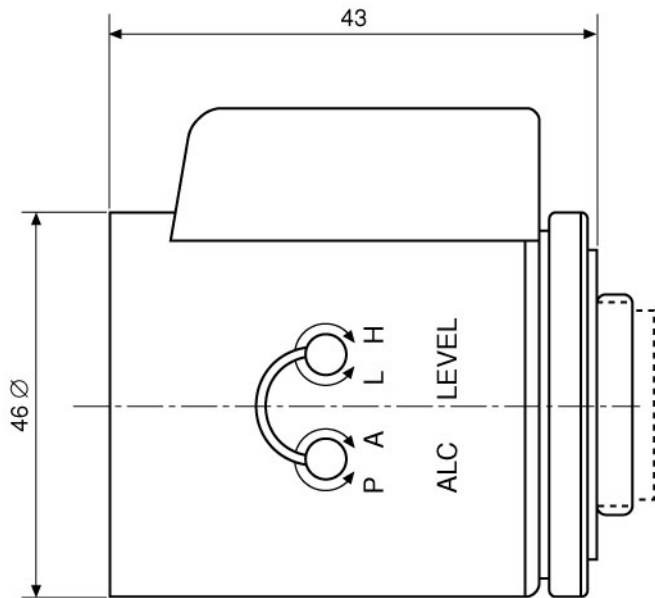

Maße/Dimensions: mm