

DH-TPC-PT8320A-T

Thermal Network Hybrid Pan & Tilt Camera



- 336x256 VOx uncooled thermal sensor technology
- Athermalized Lens(thermal), Focus-free
- 1/1.9" 2Megapixel progressive scan Sony CMOS
- Powerful 30x optical zoom
- Support temperature measurement
- Support fire detection & alarm
- Max 160°/s pan speed, 360° endless pan rotation
- Up to 300 presets, 5 auto scan, 8 tour, 5 pattern
- 7/2 alarm in/out
- Micro SD memory, IP67



System Overview

Featuring a dual lens Pan and Tilt camera, this series provides an all-in-one solution that is especially beneficial for long distance video surveillance in outdoor applications. Together with Dahua Thermal and Starlight technology, the camera's long range capabilities are able to be utilized even at night. The series combines one thermal camera for monitoring in total darkness and one camera with Starlight functionality and a motorized lens for confirming details up close.

Functions

Uncooled Vox Technology

Dahua thermal cameras use uncooled Vox sensor technology. Their small size and better performance make them a cost-effective solution for thermal security.

High Sensitivity

High thermal sensitivity (<40mK) allows cameras to capture more image details and temperature difference information.

Fire Detection & Alarm

With built-in fire detection functionality, the camera has the ability to detect fires from long range. Because thermal cameras are sensitive to temperature, they provide higher fire detection accuracy than standard cameras, making them particularly fit for applications such as forest fire prevention.

Temperature Measurement

Dahua thermal cameras (-T models) provide remote temperature monitoring functionality with the ability to set temperature threshold alarms. Object temperatures can be monitored in daytime or at night, making them ideal for usage in power plant or oil extraction applications where overheating can be dangerous. When the temperature exceeds the set threshold, an alarm is triggered. The temperature range is between -40 °C to 550 °C (-40 °F to 1022 °F).

Intelligent Video System (IVS)

IVS is a built-in video analytics algorithm that delivers intelligent functions to monitor a scene for tripwire violations, intrusion detection, and abandoned or missing objects. A camera with IVS quickly and accurately responds to monitoring events in a specific area.

Auto-tracking

The camera supports auto-tracking. The tracking action can be triggered manually or automatically by defined rules. Once rules are triggered, the camera can zoom in and track the defined target automatically.

Environmental

With a temperature range of -40 °C to +70 °C (-40 °F to +158 °F), the camera is designed for extreme temperature environments. Subjected and certified to rigorous dust and water immersion tests, the IP67 rating makes it suitable for demanding outdoor applications. For environments with rain, sleet, snow and fog, an integrated wiper provides users with clear visibility at all times.

Protection

The camera allows for ±15% input voltage tolerance, suitable for the most unstable conditions for outdoor applications. Its 6 kV lightning rating provides effective protection for both the camera and its structure against lightning.

Technical Specification

Thermal Camera

Image Sensor	Uncooled VOx Microbolometer
Effective Pixels	336(H)x256(V)
Pixel Size	17um
Thermal Sensitivity(NETD)	<40mK@f1.0
Spectral Range	7~14um
Image Setting	Brightness/Sharpness/ROI/AGC/FFC/3D DNR
Color Palettes	14(Whitehot/Blackhot/Ironrow/Icefire/ Fusion/Rainbow/Globow/Iconbow1/ Iconbow2 .etc)

Thermal Lens

Lens Type	Fixed		
Focus Control	Athermalized, Focus-free		
Focal Length	25mm	60mm	100mm
Angle of View	H:13°, V:10°	H:5.5°, V:4.2°	H:3.3°, V:2.5°
Effective Distance ^① Man(1.8m*0.5m)	D ^② :1000m R ^③ :250m I ^④ :125m	D:2000m R:510m I:260m	D:3000m R:750m I:380m
Effective Distance Vehicle(2.3m*2.3m)	D:3000m R:720m I:360m	D:6000m R:1600m I:800m	D:8800m R:2300m I:1200m

Visible Camera

Image Sensor	1/1.9" Sony CMOS
Effective Pixels	1944(H)x1092(V)
Electronic Shutter Speed	1/1 ~ 1/30,000s
Min. Illumination	0.001Lux@F1.5(Color), 0.0001Lux@F1.5(B/W)
S/N Ratio	More than 55dB
IR Distance	150m (492ft)
IR On/Off Control	Auto / Manual
IR LEDs	9

Visible Lens

Focal Length	6 ~ 180mm
Max Aperture	F1.5 ~ F4.3
Angle of View	H: 59° ~ 2.4°
Optical Zoom	30x
Focus Control	Auto / Manual
Close Focus Distance	100mm~ 1000mm (0.33ft~3.28ft)

PTZ

Pan/Tilt Range	Pan: 0° ~ 360° endless;Tilt:-40° ~ 90°
Manual Control Speed	Pan: 0.1° ~160° /s; Tilt: 0.1° ~60° /s

Preset Speed	Pan: 0.1° ~160° /s ;Tilt: 0.1° ~60° /s
Preset	300
PTZ Mode	5 Auto Scan, 8 Tour, 5 Pattern, Auto Pan
Speed Setup	Human-oriented focal length / speed adaptation
Power up Action	Auto restore to previous PTZ and lens status after power failure
Idle Motion	Activate Preset / Scan / Tour / Pattern if there is no command in the specified period
Protocol	DH-SD, Pelco-P/D (Auto recognition)

Video

Compression	H.264 / MJPEG
Frame Rate	Main Stream: Thermal: 1280x1024(default) / 720P @1~25/30fps Visible: 1080P(default) /720P @1~25/30fps Sub Stream: Thermal: 640x512(default) / 320x256 @1~25/30fps Visible: CIF(default) / D1 @1~25/30fps
Bit Rate Control	CBR / VBR
Bit Rate	H.264: 640 ~8192Kbps
Day/Night	Auto(ICR) / Color / B/W
BLC Mode	BLC / HLC / WDR
White Balance	Auto / ATW / Indoor / Outdoor / Manual
Noise Reduction	3D DNR
Motion Detetion	Off / On (4 zone, Rectangle)
Region of Interest	Off / On (4 zone)
Electronic Image Stabilization (EIS)	NA
Defog	Off / On
Digital Zoom	16x
Flip	180°
Mirror	Off / On
Privacy Masking	Off / On (4 area, Rectangle)

Temperature Measurement

Measurement Range	Low Gain: -40°C ~ +550°C High Gain:-40°C ~ +160°C
Measurement Accuracy	Max (±2°C, ±2%)
Measurement Mode	Spot / Line / Area
Measurement Preset	Spot: 12 Line: 12 Area: 12 Support 12 rules per preset simultaneously
Audio	
Compression	G.711A / G.711Mu / AAC

Intelligence	
IVS	Tripwire, Intrusion, Object Abandoned/Missing
Advanced Intelligent Functions	Fire detection & alarm, Auto Tracking
Tracking Trigger Mode	Manual / Auto (alarm triggered)
Tracking Trigger Event	Targeting, Zoom, Tracking, Recording, Snapshot, Alarm and etc.
Network	
Ethernet	RJ-45 (10/100Base-T)
Protocol	IPv4/IPv6, HTTP, HTTPS, SSL, TCP/IP, UDP, UPnP, ICMP, IGMP, SNMP, RTSP, RTP, SMTP, NTP, DHCP, DNS, PPPOE, DDNS, FTP, IP Filter, QoS, Bonjour, 802.1x
Interoperability	ONVIF Profile S&G, PSIA, CGI
Streaming Method	Unicast / Multicast
Max. User Access	10 Users / 20 Users
Edge Storage	Micro SD (128GB) Memory status display (Normal / Error / Active / Formatting / Lock), NAS (Network Attached Storage), Local PC for instant recording
Web Viewer	<IE11, <Chrome45, <Firefox52
Management Software	Smart PSS, DSS
Smart Phone	Android, ios
Certifications	
Certification	CE (EN 60950:2000) FCC (FCC Part 15 Subpart B)
Interface	
Video Interface	1.0Vp-p/75Ω, PAL / NTSC (HDCVI Optional)
Audio Interface	Input/Output 1 Input / 1 Output
RS485	Support
Alarm	7/2 In/Out
Electrical	
Power Supply	24V AC ±15%
Power Consumption	Max. 70W (24V AC, Heater on)
Environmental	
Operating Condition	-40°C ~ +70°C (-40°F ~ +158°F) / Less than 95% RH * Start up should be done at above -40°C (-40°F)
Storage Conditions	-40°C ~ +70°C (-40°F ~ +158°F) / Less than 95% RH
Ingress Protection	IP67
Construction	
Casing	Metal
Dimensions	345mm x 252mm x 470mm (13.58" x 9.92" x 18.50")
Net Weight	13Kg (28.66lb)
Gross Weight	25Kg (55.12lb)

Note:

- ① Effective distance values shown are nominal values and should be used as estimates only. Exact value calculations depend on a wide variety of conditions.
- ② D: Detection Distance
- ③ R: Recognition Distance
- ④ I: Identification Distance

Ordering Information

Type	Part Number	Description
DH-TPC-PT8320A-T	DH-TPC-PT8320AP-TA25Z30 DH-TPC-PT8320AN-TA25Z30	Thermal: 336x256 25mm lens Visible: 2MP 30X Temperature measurement
	DH-TPC-PT8320AP-TA60Z30 DH-TPC-PT8320AN-TA60Z30	Thermal: 336x256 60mm lens Visible: 2MP 30X Temperature measurement
	DH-TPC-PT8320AP-TA100Z30 DH-TPC-PT8320AN-TA100Z30	Thermal: 336x256 100mm lens Visible: 2MP 30X Temperature measurement

Accessories

Included:



AC24V/5A
Power Supply

Mounting Type

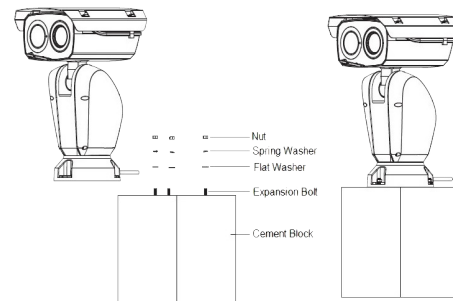

Dimensions (mm)

