

DH-SD65F230F-HNI

2 Megapixel Full HD 30x WDR Starlight Network PTZ Dome Camera



Features

- Powerful 30x optical zoom
- Ultra-low light star-light camera
- H.264 & MJPEG Triple-stream encoding
- Max 60fps@720P and 30fps@1080P resolution
- Defog, WDR, EIS, ROI, Day/Night(ICR), DNR (2D&3D), Auto iris, Auto focus, AWB, AGC,BLC
- Auto-tracking and IVS
- Multiple network monitoring: Web viewer, CMS(DSS/PSS) & DMSS
- Max 600°/s pan speed, 360° endless pan rotation
- Up to 300 presets, 5 auto scan, 8 tour, 5 pattern
- Built-in 7/2 alarm in/out
- Support intelligent 3D positioning with DH-SD protocol
- Micro SD memory, IP67, IK10, POE+

DH-SD65F230F-HNI

Technical Specifications

Model	DH-SD65F230F-HNI
Camera	
Image Sensor	1/1.9" Exmor CMOS
Effective Pixels	1920(H)×1080(V)
Scanning System	Progressive
Electronic Shutter Speed	1/1 ~ 1/30,000s
Min. Illumination	Color: 0.002Lux@F1.6; B/W: 0.0002Lux@F1.6
S/N Ratio	More than 50dB
Video Output	BNC(1.0Vp-p/75Ω), PAL / NTSC
Camera Features	
Day/Night	Auto(ICR) / Color / B/W
Backlight Compensation	BLC / HLC / WDR (120dB)
White Balance	Auto, ATW, Indoor, Outdoor, Manual
Gain Control	Auto / Manual
Noise Reduction	Ultra DNR (2D/3D)
Privacy Masking	Up to 24 areas
Digital Zoom	16x
Lens	
Focal Length	6mm~180mm (30x Optical zoom)
Max Aperture	F1.6 ~ F4.8
Focus Control	Auto / Manual
FOV-H	H: 61.2° ~ 2.1°
Close Focus Distance	100mm~ 1000mm
PTZ	
Pan/Tilt Range	Pan: 0° ~ 360° endless; Tilt: -20° ~ 90°, auto flip 180°
Manual Control Speed	Pan: 0.1° ~300° /s; Tilt: 0.1° ~150° /s
Preset Speed	Pan: 600° /s; Tilt: 500° /s
Preset	300
PTZ Mode	5 Pattern, 8 Tour, Auto Pan, Auto Scan
Speed Setup	Human-oriented focal length/ speed adaptation
Power up Action	Auto restore to previous PTZ and lens status after power failure
Idle Motion	Activate Preset/ Pan/ Scan/ Tour/ Pattern if there is no command in the specified period
Protocol	DH-SD, Pelco-P/D (Auto recognition)
Video	
Compression	H.264 / MJPEG
Resolution	1080P(1920×1080) / 720P(1280×720) / D1(704×576/ 704×480) /CIF (352×288/352×240)

DH-SD65F230F-HNI



Frame Rate	Main Stream	1080P/ D1 (1 ~ 25/30fps), 720P(1~50/60fps)
	Sub Stream 1	D1/CIF(1 ~ 25/30fps)
	Sub Stream 2	720P/D1/ CIF (1 ~ 25/30fps)
Bit Rate		H.264: 56K ~ 8192Kbps, MJPEG: 56K ~ 20480Kbps
Audio		
Compression		G.711a / G.711u(32kbps)/ PCM(128kbps)
Interface		1/1 channel In/Out
Intelligent Function		
Auto Tracking		Single-scene, multiple-scene, panorama-scene
IVS(Optional)		Tripwire, Intrusion, Cross Warning Zone, Perimeter Protection, Loitering Detection, Abandoned Object Detection, Missing Object Detection, Illegal Parking, Fast Moving and etc.
Tracking Trigger Mode		Manual / Auto (alarm triggered)
Tracking Trigger Event		Targeting, Zoom, Tracking, Recording, Snapshot, Alarm and etc.
Network		
Ethernet		RJ-45 (10/100Base-T)
Protocol		IPv4/ IPv6, HTTP, HTTPS, SSL, TCP/IP, UDP, UPnP, ICMP, IGMP, SNMP, RTSP, RTP, SMTP, NTP, DHCP, DNS, PPPOE, DDNS, FTP, IP Filter, QoS, Bonjour, 802.1x
Compatibility		ONVIF PSIA CGI
Max. User Access		20 users
Smart Phone		iPhone, iPad, Android, Windows Phone
Auxiliary Interface		
Memory Slot		Micro SD, Max 128GB
RS485		1
Alarm		7/2 channel In/Out
General		
Power Supply		AC 24V/3A (±25%) POE+(802.3at)
Power Consumption		13W,20W (Heater on)
Working Environment		-40°C ~ 70°C / Less than 90% RH
Ingress Protection		IP67, IK10
Dimensions		Φ242(mm) x 341 (mm)
Weight		7.5kg

DH-SD65F230F-HNI

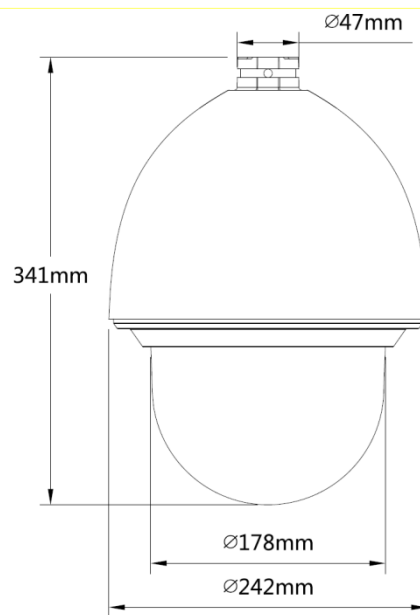
Dimensions (mm)









Accessories

	
DH-PFB303W	Power Supply

DH-SD65F230F-HNI

Accessories (Optional)

						
PFA111	PFB300C	PFA112	PFA113	PFA120	PFA150	PFA151

Dahua Technology Co., Ltd.

1199 BinAn Road, Binjiang District, Hangzhou, China

Tel: +86-571-87688883

Fax: +86-571-87688815

Email: overseas@dahuatech.com

www.dahuasecurity.com

*Design and specifications are subject to change without notice.

© 2013 Dahua Technology