

TG2616FCS-4

2.6mm F1.6
for 1/3 type Cameras, Fixed-focal Auto Iris DC Drive
CS-Mount

with Focus, w/o Amplifier

Model No.	TG2616FCS-4		Effective	Front	Ø16.4mm
Focal Length	2.6mm		Lens Aperture	Rear	Ø8mm
Max. Aperture Ratio	1:1.6		Back Focal Length	7.5mm	
Max. Image Format	4.8mm x 3.6mm(Ø6mm)		Flange Back Length	12.5mm	
Operation Range	Iris	F1.6 - F360C	Mount	CS-Mount	
	Focus	0.3m - Inf.	Filter Size	—	
Control	Iris	DC Auto Iris	Dimensions	Ø32mm x 39.8mm x 34.7mm	
	Focus	Manual	Weight	42g	
Object Dimension at M.O.D.	71cm x 46.4cm				
Angle of View	D	1/3 type	123.0°	1/4 type	93.8°
	H			75.4°	
	V			56.9°	
Coil	Drive	190Ω			
	Control	855Ω			
Operating Temperature	-20°C - +50°C				

1/3 type

M.O.D : Minimum Object Distance

Dimensions

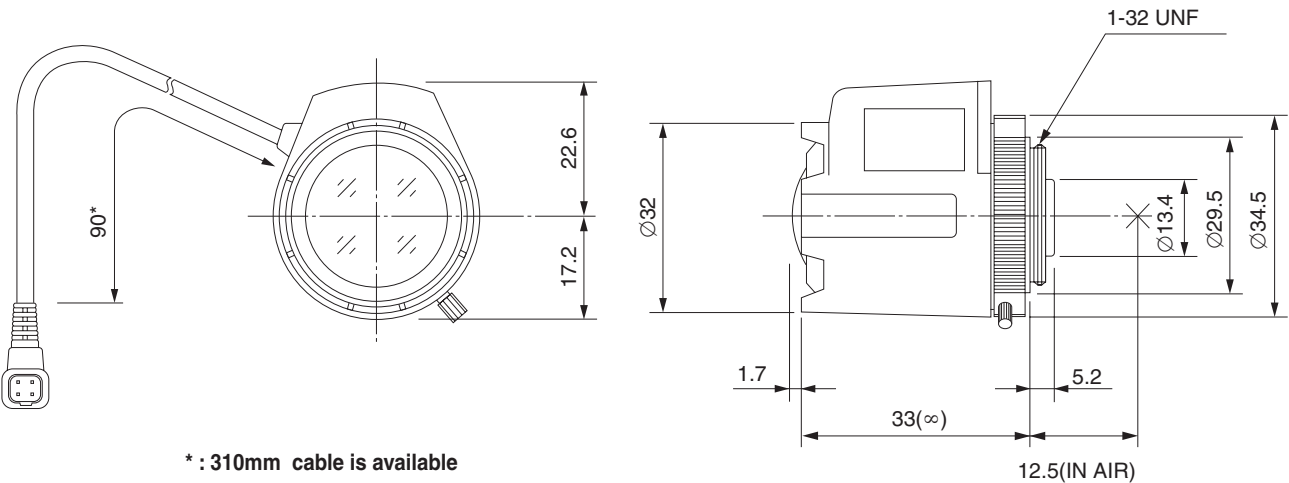

CS

Wiring Diagram

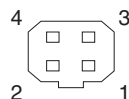

Pin No.

1	BROWN	Control (-)
2	RED	Control (+)
3	YELLOW	Drive (+)
4	ORANGE	Drive (-)