

M5018-MP

50mm F1.8

for 2/3" format cameras

C-Mount

Model No.	M5018-MP		Effective	Front	f 25.5mm
Focal Length	50mm		Lens Aperture	Rear	f 9.6mm
Max. Aperture Ratio	1 : 1.8		Distortion	-0.3%(y=4.0)	
Max. Image Format	8.8 x 6.6mm (f11mm)		Back Focal Length	13.1mm	
Operation Range	Iris	F1.8 - 16C	Flange Back Length	17.526mm	
	Focus	0.5m - Inf.	Mount	C-Mount	
Control	Iris	Manual	Filter Size	M30.5 P=0.5mm	
	Focus	Manual	Dimensions	f33.5 x 38.1mm	
Object Dimension at M.O.D.	9.2 x 6.9cm		Weight	90g	
Angle of View	D	13.1°	1/2"	9.5°	
	H	10.5°		7.6°	
	V	7.9°		5.7°	
Operating Temperature	-20°C ~ +50°C				

2/3

C

M.O.D. : Minimum Object Distance

Dimensions

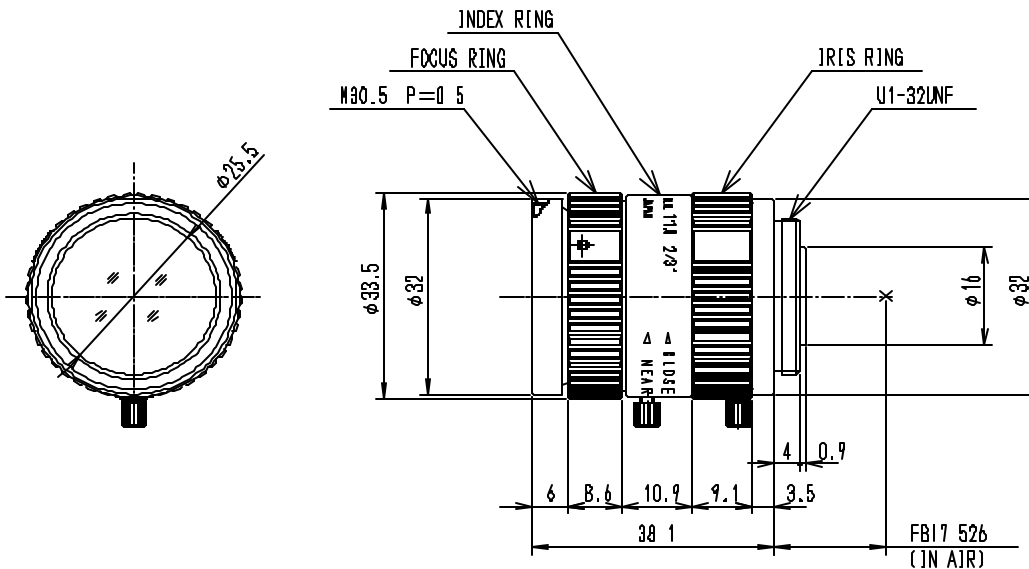

F