

HG4514FCS-3

4.5mm F1.4
for 1/2" format cameras
CS-Mount

with Focus, w/o Amplifier

Model No.	HG4514FCS-3		Effective	Front	φ 15.8 mm
Focal Length	4.5mm		Lens Aperture	Rear	φ 9.0 mm
Max. Aperture Ratio	1 : 1.4		Back Focal Length	8.7 mm	
Max. Image Format	6.4 x 4.8mm (φ 8mm)		Flange Back Length	12.5 mm	
Operation Range	Iris	F1.4 ~ 360	Mount	CS-Mount	
	Focus	0.2m ~ Inf.	Filter Size	M30.0 P=0.5	
Control	Iris	Auto Iris(by galvanometer)	Dimensions	φ 32.0 × 39.8 × 33.0 mm	
	Focus	Manual	Weight	38g	
Object Dimension at M.O.D.	33.3 x 22.9cm				
Angle of View	D	100.1°			
	H	79.6°			
	V	59.5°			
Coil	Drive	190 Ω			
	Control	855 Ω			
Operating Temperature	-20 ~ +50° C				

1/2

CS

AG

M.O.D. : Minimum Object Distance

Dimensions

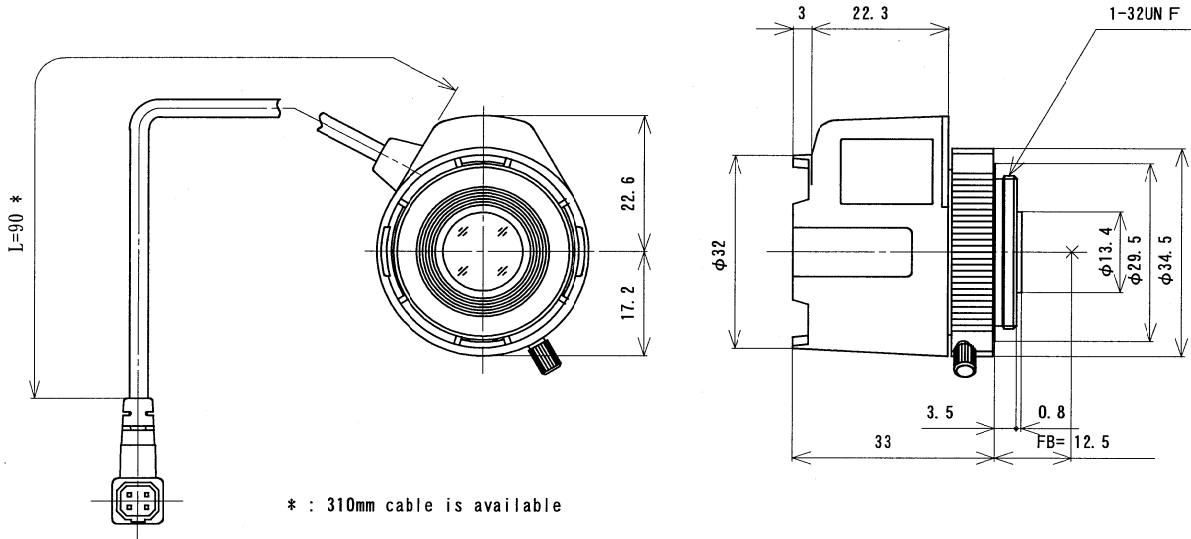

Wiring Diagram

