

# Outdoor Dome Cameras

[www.boschsecurity.com](http://www.boschsecurity.com)



**BOSCH**

Invented for life



Advantage Line

The VDX-240 Outdoor Dome range comes in robust, conduit compatible, all-weather housings (IP66 rated) and provides high-resolution (540TVL) images.

The color version provides crisp, clear images in applications with sufficient lighting. The day/night version switches to monochrome mode with a higher light sensitivity when there is insufficient lighting. For applications requiring extra lighting, the infrared version has 20 on-board IR LEDs providing 20 meters of night vision.

## Features

- ▶ Three versions for all lighting environments
- ▶ Flexible viewing field
- ▶ Easy setup
- ▶ Secure all-weather installation

## 2 | Outdoor Dome Cameras

### Technical Specifications

Video	
CCD Camera	1/3-inch High Sensitivity CCD
Effective pixels (HxV)	752X582 (PAL) 768x494 (NTSC)
Color Resolution	540 TVL (min.)
B/W Resolution	580 TVL (min.)
Electronics Iris	1/50 to 1/120,000 s (PAL) 1/60 to 1/120,000 s (NTSC)
Manual shutter	1/50 (1/60), 1/100 (1/120), 1/250, 1/500, 1/700, 1/1K, 1/1.6K, 1/2.5K, 1/5K, 1/7K 1/10K, 1/30K, 1/60K, 1/120K
Output Signal	1 VPP composite video, 75 ohm
Output connection	BNC connector
S/N Ratio	Greater than 50 dB
Gamma	0.35, 0.45 (default), 0.6, 0.75
Lens (VDC-240)	2.8 to 10.5 mm varifocal auto-iris
Lens (VDN-240)	2.8 to 10.5 mm varifocal auto-iris with mechanical D/N filter
Lens (VDI-240)	3.8 to 9.5 mm varifocal auto-iris with mechanical D/N filter
Sensitivity	0.05 lx (color), 0.005 lx (b/w), 0 lx (infrared on)
VDI-240	
LEDs	Intelligent 20-LED infrared array
Wavelength	850 nm
Mechanical	
Housing	Surface mount dome, vandal resistant
Gimbals	3D gimbal for easy installation
Construction	Robust aluminum
Finish	Off-white
Conduit Compatible	1/2-inch PT, top and side
Electrical	
Power Consumption	VDC-240: 3.6 W max. VDN-240: 3.6 W max. VDI-240: 6 W max.
Voltage	12 VDC or 24 VAC
Power Supply	Not included
Environmental	
Operational Temp.	-10 °C to +50 °C (14 °F to +122 °F)
Storage Temp.	-20 °C to +60 °C (-4 °F to +140 °F)
Environment	IP66 certified
Certifications and Approvals	
Region	Certification
Europe	CE
Standards	
	ANSI C63.4: 2009
	FCC Part 15 subpart B, Class A
	UL 60065, 7th Edition, 2007-12-11
	CAN/CSA-C22.2 No. 60065-03, 1st Edition, 2006-04 + A1:2006
	EN55022:2006, Class A
	EN50130-4:1995+A1:1998+A2:2003
	LVD 2006/95/EC
	EN60065:2002 + A1:2006 + A11:2008
	IP66, IEC 60529 (2001), IEC 60529 (2002)

### Installation/Configuration Notes

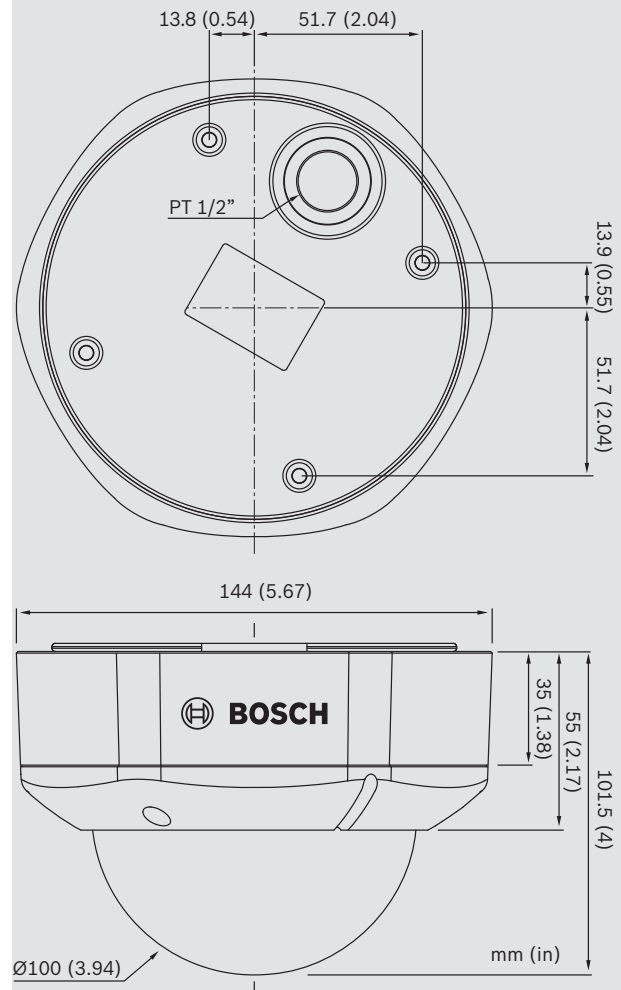

### Ordering Information

VDC-240V03-1 Outdoor Color Dome Camera, PAL	VDC-240V03-1
VDC-240V03-2 Outdoor Color Dome Camera, NTSC	VDC-240V03-2
VDN-240V03-1 Outdoor D/N Dome Camera, PAL	VDN-240V03-1
VDN-240V03-2 Outdoor D/N Dome Camera, NTSC	VDN-240V03-2
VDI-240V03-1 Outdoor IR D/N Dome Camera, PAL	VDI-240V03-1
VDI-240V03-2 Outdoor IR D/N Dome Camera, NTSC	VDI-240V03-2

**Represented by:****Americas:**

Bosch Security Systems, Inc.  
130 Perinton Parkway  
Fairport, New York, 14450, USA  
Phone: +1 800 289 0096  
Fax: +1 585 223 9180  
security.sales@us.bosch.com  
www.boschsecurity.us

**Europe, Middle East, Africa:**

Bosch Security Systems B.V.  
P.O. Box 80002  
5617 BA Eindhoven, The Netherlands  
Phone: +31 40 2577 284  
Fax: +31 40 2577 330  
emea.securitysystems@bosch.com  
www.boschsecurity.com

**Asia-Pacific:**

Robert Bosch (SEA) Pte Ltd, Security Systems  
11 Bishan Street 21  
Singapore 573943  
Phone: +65 6571 2808  
Fax: +65 6571 2699  
apr.securitysystems@bosch.com  
www.boschsecurity.asia

**China:**

Bosch (Shanghai) Security Systems Ltd.  
201 Building, No. 333 Fuquan Road  
North IBP  
Changning District, Shanghai  
200335 China  
Phone +86 21 22181111  
Fax: +86 21 22182398  
www.boschsecurity.com.cn

**America Latina:**

Robert Bosch Ltda Security Systems Division  
Via Anhanguera, Km 98  
CEP 13065-900  
Campinas, Sao Paulo, Brazil  
Phone: +55 19 2103 2860  
Fax: +55 19 2103 2862  
al.securitysystems@bosch.com  
www.boschsecurity.com