

Varifocal Lenses

www.boschsecurity.com



BOSCH
Invented for life



- ▶ High-quality optics
- ▶ 1/3-inch and 1/2-inch formats
- ▶ Reliable, robust construction
- ▶ Focal length options
- ▶ Compact design

For optimizing angular fields right on site, varifocal lenses are the most versatile and practical solution available. These lenses allow for setting virtually any angle of field, which maximizes surveillance effects. Installers do not need to carry several different focal length lenses – and installation is more efficient because they can find the right angles of field without moving the camera set-up. If the field-of-view requirements change after installation, modification is simple by just altering the lens' focal length settings.

Functions

This series includes several DC-iris varifocal lenses. They are compact, rugged, and available in 1/3-inch and 1/2-inch image formats. The series is organized by sensitivity, optical resolution, and range to match the wide range of Dinion camera applications. These varifocal lenses come with a standard C or CS mount for use with a variety of cameras. The DC-iris control connection is a four-pin standard plug that fits directly into the camera's iris output. And the lenses deliver impressive optical quality due to their high standards for resolution, contrast reproduction, and coating.

The mechanical construction is designed to withstand both frequent DC-iris control operations and the environmental stress of security installations. For flexible, high-quality, reliable lenses that match a camera's performance, this varifocal series is the ideal solution.

Certifications and approvals

Region	Certification
Europe	CE

Installation/configuration notes

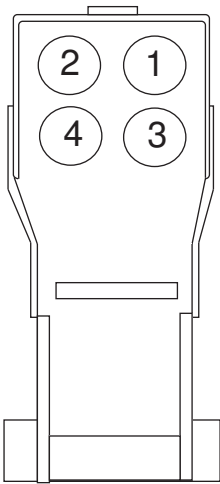

4-pin DC-iris connector (front view)

- 1 Damping coil -
- 2 Damping coil +
- 3 Driving coil + (open)
- 4 Driving coil -

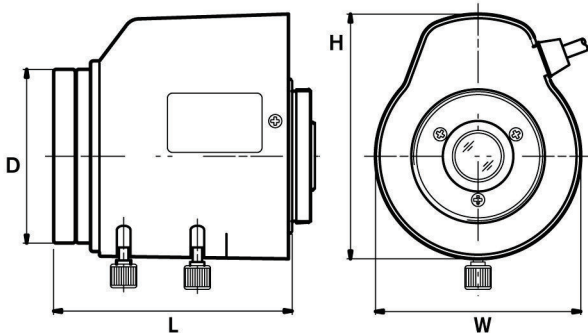

Lens Type	L	D	H	W
	mm (in)	mm (in)	mm (in)	mm (in)
LTC 3274/41	77 (3.03)	42 (1.65)	56.8 (2.24)	46.5 (1.83)
LTC 3664/30	44.4 (1.75)	35.2 (1.39)	44.7 (1.76)	38.3 (1.51)
LTC 3364/50	55 (2.17)	34 (1.34)	46 (1.81)	40 (1.57)
LTC 3364/60	45.3 (1.78)	33 (1.3)	46.5 (1.83)	39 (1.54)
LTC 3374/50	61.5 (2.42)	44 (1.73)	52.2 (2.06)	44.4 (1.75)

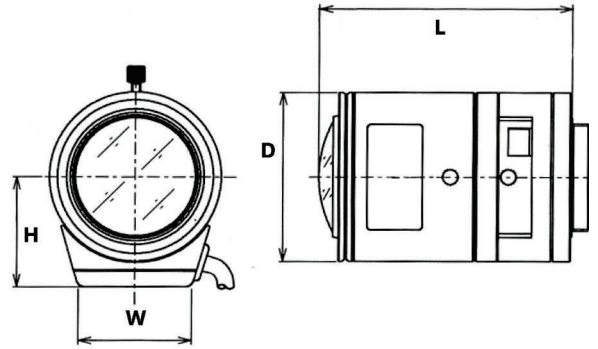

Lens Type	L	D	H	W
	mm (in)	mm (in)	mm (in)	mm (in)
LTC 3664/40	59 (2.32)	44 (1.73)	26.2 (1.03)	26.4 (1.04)
LTC 3674/20	55.2 (2.17)	38 (1.5)	27.2 (1.07)	31 (1.22)
LTC 3764/20	53.9 (2.12)	40 (1.57)	31 (1.22)	24.6 (0.97)
LTC 3774/30	62 (2.44)	38.6 (1.52)	31.1 (1.22)	31.8 (1.25)
LTC 3664/31	42.8 (1.69)	33 (1.3)	25.5 (1.0)	22.7 (0.9)

Technical specifications

Electrical/mechanical

See comparison table at the end of this datasheet.

Environmental

Operating Temperature	-10°C to +50°C (+14°F to +122°F)
Storage Temperature	-40°C to +70°C (-40°F to +158°F)
Operating Humidity	Up to 93% non-condensing
Certification	CE

Ordering information

LTC 3364/41 Varifocal Lens

1/3-inch, 2.8 to 12 mm, DC-iris, CS-mount F1.4-360, 4-pin

Order number **LTC 3364/41**

LTC 3364/50 Varifocal Lens

1/3-inch, 2.8 – 10 mm, DC-iris, CS-mount, F1.4-360, 4 pin

Order number **LTC3364/50**

LTC 3364/60 Varifocal Lens

1/3-inch, 3.5 – 8 mm, DC-iris, CS-mount F1.4-360, 4-pin

Order number **LTC3364/60**

LTC 3374/50 Varifocal Lens

1/3-inch, 5 – 50 mm, DC-iris, CS-mount F1.7-360, 4-pin
Order number **LTC3374/50**

LTC 3374/21 Varifocal Lens

1/3-inch, 5 to 50 mm, DC-iris, CS-mount F1.4-360, 4-pin
Order number **LTC 3374/21**

Varifocal Lens

960H, 1/3-inch, 3-8 mm, DC-iris, CS-mount F1.0, IR corrected lens
Order number **LTC 3664/31**

LTC 3664/40 Varifocal Lens IR corrected

1/3-inch, 2.8 – 11 mm, DC-iris, CS-mount F1.4-360, 4-pin
Order number **LTC3664/40**

LTC 3674/20 Varifocal Lens IR corrected

1/3-inch, 7.5 – 50 mm, DC-iris, CS-mount F1.3-360, 4-pin
Order number **LTC 3674/20**

LTC 3764/20 Varifocal Lens IR corrected

1/2-inch, 4 – 12 mm, DC-iris, C-mount F1.2-360, 4-pin
Order number **LTC 3764/20**

LTC 3774/30 Varifocal Lens IR corrected

1/2-inch, 10 – 40 mm, DC-iris, C-mount F1.4-360, 4-pin
Order number **LTC 3774/30**

LTC 3274/41 Varifocal Lens





1/2-inch, 7.5 – 75 mm, DC-iris, C-mount, F1.7-360, 4-pin
Order number **LTC3274/41**





Accessories

S1374 Adapter



converts C mount lens to CS mount camera
Order number **S1374**

Varifocal Lenses 1/3 and 1/2 inch

	LTC 3364/50 Varifocal Lens	LTC 3364/60 Varifocal Lens	LTC 3364/41 Varifocal Lens	LTC 3374/50 Varifocal Lens
				
Image format	1/3 inch	1/3 inch	1/3 inch	1/3 inch
Focal length	2.8 – 10 mm	3.5 – 8 mm	2.8 – 12 mm	5 – 50 mm
Iris range	F1.4 - 360	F1.4 - 360	F1.4 - 360	F1.7 - 360
Min object distance	0.3 m (1 ft)	0.3 m (1 ft)	0.3 m (1 ft) to inf.	1 m (3.3 ft)
Back focus distance	7.8 mm (0.3 in)	8.4 mm (0.33 in)	8.6 mm (0.34 in)	7.6 mm (0.3 in)
Weight	69 g (0.15 lb)	53 g (0.12 lb)	71 g (0.16 lb)	160 g (0.35 lb)
Lens mount	CS	CS	CS	CS
Angle view Wide (1/3 in.)	83 x 62.4	77.6 x 58.2	97.4 x 72.5	50 x 37.8
Angle view Tele (1/3 in.)	28.8 x 21.6	33.6 x 52	24.1 x 18.1	5.5 x 4.1
Angle view Wide (1/2 in.)	-	-	-	-
Angle view Tele (1/2 in.)	-	-	-	-
Iris control	4-pin, DC control	4-pin, DC control	4-pin, DC control	4-pin, DC control
Focus ctrl	manual	manual	manual	manual
Zoom ctrl	manual	manual	manual	manual
IR corrected	no	no	no	no

	LTC 3374/21 Varifocal Lens	Varifocal Lens	LTC 3664/40 Varifocal Lens IR corrected	LTC 3674/20 Varifocal Lens IR corrected
				
Image format	1/3 inch	1/3 inch	1/3 inch	1/3 inch
Focal length	5 – 50 mm	3.0 – 8 mm	2.8 – 12 mm	7.5 – 50 mm
Iris range	F1.4 - 360	F1.0 - 360	F1.4 - 360	F1.3 - 360
Min object distance	1 m (3.3 ft)	0.2 m (0.7 ft to inf.)	0.3 m (1 ft) to inf.	0.4 m (1.3 ft)
Back focus distance	10.05 mm (0.4 in)	8.5 mm (0.33 in)	8.6 mm (0.34 in)	8.1 mm (0.32 in)
Weight	84 g (0.19 lb)	45 g (0.1 lb)	79 g (0.17 lb)	68 g (0.15 lb)
Lens mount	CS	CS	CS	CS
Angle view Wide (1/3 in.)	53.4 x 40.1	92.5 x 68	97.4 x 72.4	36.6 x 27.4
Angle view Tele (1/3 in.)	5.3 x 4.1	35.7 x 26.8	26.2 x 19.7	5.6 x 4.3
Angle view Wide (1/2 in.)	-	-	-	-
Angle view Tele (1/2 in.)	-	-	-	-
Iris control	4-pin, DC control	4-pin, DC control	4-pin, DC control	4-pin, DC control

	LTC 3374/21 Varifocal Lens	Varifocal Lens	LTC 3664/40 Varifocal Lens IR corrected	LTC 3674/20 Varifocal Lens IR corrected
Focus ctrl	manual	manual	manual	manual
Zoom ctrl	manual	manual	manual	manual
IR corrected	no	yes	yes	yes

	LTC 3764/20 Varifocal Lens IR corrected	LTC 3774/30 Varifocal Lens IR corrected	LTC 3274/41 Varifocal Lens
			
Image format	1/2 inch	1/2 inch	1/2 inch
Focal length	4 – 12 mm	10 – 40 mm	7.5 – 75 mm
Iris range	F1.2 - 360	F1.4 - 360	F1.7 – 360
Min object distance	0.3 m (1.0 ft)	0.5 m (1.6 ft)	0.3 m (1 ft)
Back focus distance	9 mm (0.35 in)	12.4 mm (0.49 in)	8.5 mm (0.34 in)
Weight	68 g (0.15 lb)	87 g (0.19 lb)	220 g (0.48 lb)
Lens mount	C	C	C
Angle view Wide (1/3 in.)	68.9 x 51.3	27.5 x 20.4	35.5 x 26.6
Angle view Tele (1/3 in.)	23.4 x 17.5	7.0 x 5.2	3.7 x 2.8
Angle view Wide (1/2 in.)	93.6 x 68.9	37.5 x 27.5	46.2 x 35.5
Angle view Tele (1/2 in.)	31.2 x 23.4	9.2 x 7.0	4.9 x 3.7
Iris control	4-pin, DC control	4-pin, DC control	4-pin, DC control
Focus ctrl	manual	manual	manual
Zoom ctrl	manual	manual	manual
IR corrected	yes	yes	no

Represented by:**Americas:**

Bosch Security Systems, Inc.
130 Perinton Parkway
Fairport, New York, 14450, USA
Phone: +1 800 289 0096
Fax: +1 585 223 9180
security.sales@us.bosch.com
www.boschsecurity.us

Europe, Middle East, Africa:

Bosch Security Systems B.V.
P.O. Box 80002
5617 BA Eindhoven, The Netherlands
Phone: + 31 40 2577 284
Fax: +31 40 2577 330
emea.securitysystems@bosch.com
www.boschsecurity.com

Asia-Pacific:

Robert Bosch (SEA) Pte Ltd, Security Systems
11 Bishan Street 21
Singapore 573943
Phone: +65 6571 2808
Fax: +65 6571 2699
apr.securitysystems@bosch.com
www.boschsecurity.asia

China:

Bosch (Shanghai) Security Systems Ltd.
201 Building, No. 333 Fuquan Road
North IBP
Changning District, Shanghai
200335 China
Phone +86 21 22181111
Fax: +86 21 22182398
www.boschsecurity.com.cn

America Latina:

Robert Bosch Ltda Security Systems Division
Via Anhanguera, Km 98
CEP 13065-900
Campinas, Sao Paulo, Brazil
Phone: +55 19 2103 2860
Fax: +55 19 2103 2862
latam.boschsecurity@bosch.com
www.boschsecurity.com