



**PY-MMBRD Pyramid to Mark Mercer  
Interface Installation Instructions**

Please read this manual before installing your PY-MMBRD Module

Use this manual in conjunction with

- Manual 1 - Operating Instructions
- Manual 2 - Network Wiring
- The instructions provided with your Mark Mercer dome

---

**IMPORTANT**

The first few pages of these instructions contain important information on safety and product conformity. Please read, and ensure that you understand this information before continuing.

---

---

**CONTENTS**

---

**Product Safety** ..... 4

**Product Safety and Electromagnetic Compatibility (EMC)** ..... 4

**Manufacturer’s Declaration of Conformance** ..... 5

Terminology ..... 5

Unpacking ..... 5

Functional Description ..... 6

Physical Description ..... 6

Installation ..... 7

Mounting ..... 7

Mark Mercer Network Connections ..... 8

Pyramid Network Connections ..... 8

Typical Network Connections ..... 9

Connecting the Power ..... 10

Connecting the 12V DC Power Supply ..... 11

Switching On and Configuration ..... 11

Operation using the Pyramid Keyboard ..... 11

Updating your PY-MMBRD Software ..... 12

Setting Presets ..... 12

‘NO Rx’ Message for Camera which has a receiver ..... 12

Specifications ..... 13

Appendix A - PY-MMBRD internal links ..... 14

---

**PRODUCT SAFETY**

---

Please follow these instructions as you install your Pyramid module and retain them for future use. If you have any problems, contact your Baxall agent.

**⚠ WARNING**

**Installation is only to be carried out by competent, qualified and experienced personnel.**

**Wire in accordance with your national wiring regulations. Failure to do so can result in injury or death by electric shock.**

**Use a class 2 isolated power supply for the 12V DC**

This product must not be used for intrinsically safe or medical applications.

**⚠ CAUTION**

**Do not exceed the voltage and temperature limits given in the specification.**

---

**PRODUCT SAFETY AND ELECTROMAGNETIC COMPATIBILITY (EMC)**

---

**⚠ CAUTION**

**This is a Class A product. In a domestic environment this product may cause radio interference in which case the user may be required to take adequate measures.**

This product is intended for use in general purpose CCTV applications in a residential, commercial or light industrial EMC environment, refer to Baxall Limited before using the product in an industrial EMC environment.

The product must be installed in accordance with good installation practice to enable the product to function as intended and to prevent problems. Refer to your agent for installation guidance.

Contact your agent to obtain a specification defining the acceptable levels of product degradation with regard to EMC immunity.

---

**MANUFACTURER'S DECLARATION OF CONFORMANCE**

---

The manufacturer declares that the product supplied with this manual is compliant with the essential protection requirements of the EMC directive 89/336 and the Low Voltage Directive LVD 73/23 EEC. Conforming to the requirements of standards EN 55022 for emissions and IEC801 parts 2, 3 and 4 for immunity and BS415 superseded by EN60950 for Electrical Equipment Safety.

---

**TERMINOLOGY**

---

Camera numbers are decided by which video input (on the matrix) they are connected to.

The phrases 'camera number' and 'receiver number' are used throughout the document. They are used interchangeably and refer to the same value.

The receiver number is the same as the camera number to which it is attached as selected at the keyboard.

---

**UNPACKING**

---

Keep your packaging for use if your PY-MMBRD is stored for a time or needs to be returned for whatever reason. The packaging should contain:

- Your PY-MMBRD
- An IEC mains connector
- These Instructions

Check the product code on the serial number label. If you have an incorrect item or it is damaged then inform the suppliers and carriers immediately. If this is the case then do not attempt to use your PY-MMBRD.

---

**FUNCTIONAL DESCRIPTION**

The Mark Mercer interface (PY-MMBRD) is for connecting an existing functional and correctly configured Mark Mercer network to a Pyramid system. Baxall strongly recommend that any outstanding problems are resolved before connecting and using the PY-MMBRD.

The PY-MMBRD allows you to use Mark Mercer domes with the Pyramid video management system. The installation of your PY-MMBRDs is simple because they are self-configuring. The Mark Mercer receivers need to be configured to fit in the numbering of the Pyramid Matrix inputs. The video should also be connected to the appropriate matrix input (i.e. the address of Mark Mercer receiver should match the video input on the matrix).

---

**PHYSICAL DESCRIPTION**

The PY-MMBRD is provided as a 19" x 1U rack mounting unit. It can be split into a separate wall mounted unit by removing the 5 screws holding in the PY-MMBRD electronics.

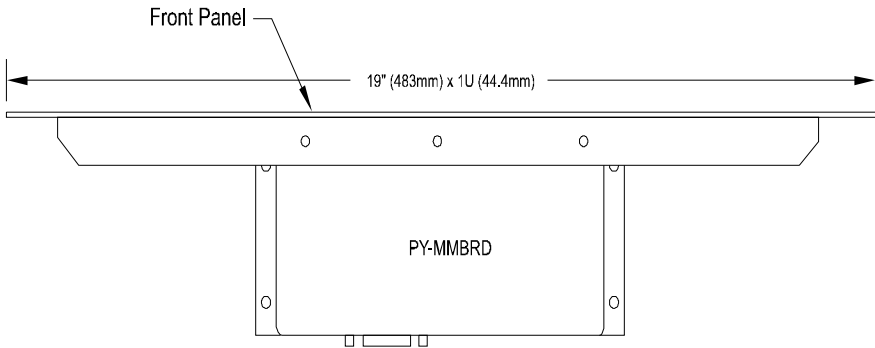

Fig.1 PY-MMBRD Layout

The front panel is blank except for an identifying label. The rear of the PY-MMBRD is shown in Fig. 2.

**PHYSICAL DESCRIPTION**

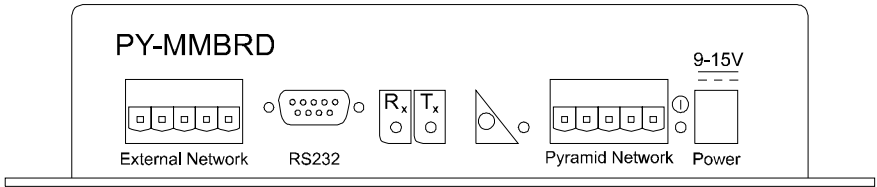

Fig. 2 PY-MMBRD rear layout

On the PY-MMBRD, the important connections are for:

1. the Mark Mercer network
2. the Pyramid network
3. power

**The RS232 interface is not currently used.**

The back panel also contains a service-pin button and LED, and 3 diagnostic LEDs Receive (Rx), Transmit (Tx) and Power.

**INSTALLATION**

Mount the unit, connect the Pyramid network and the Mark Mercer network to *all* your PY-MMBRDs then connect the power. All connections on the Mark Mercer network must be daisy-chained. This includes all the PY-MMBRDs you are adding. No further connections are necessary. Note that Mark Mercer domes can only be addressed up to 99. It is not currently possible to use domes on inputs 100 to 144 on a Pyramid system.

**MOUNTING**

The unit is supplied fitted to a 1U front plate suitable for mounting in a 19" rack. If you want to mount the PY-MMBRD electronics separately, remove the 5 screws shown below. Mount the PY-MMBRD using the 4 mounting holes shown in Fig. 4.

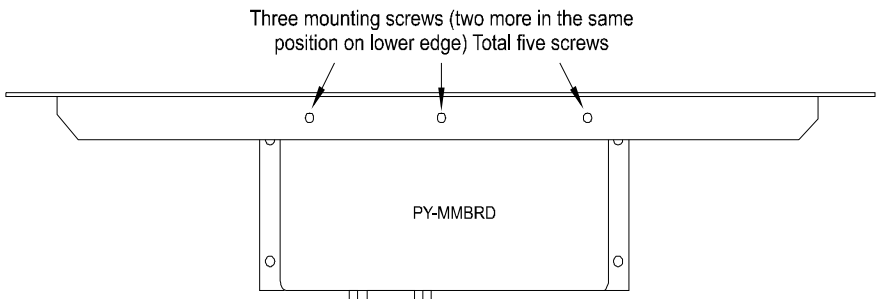

**MOUNTING**

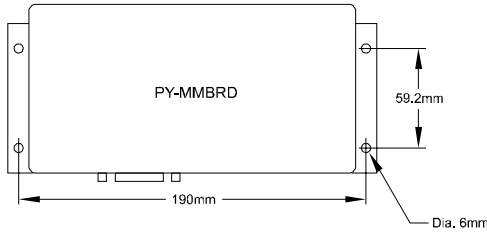

Fig. 4 Mounting holes for separate mounting of the PY-MMBRD electronics

**⚠ WARNING**

**Only use the Class 2 isolated power supply provided. Do not use it to power more than one PY-MMBRD.**

**MARK MERCER NETWORK CONNECTIONS**

Note that all the Mark Mercer connections on the PY-MMBRDs and all nodes on the Mark Mercer network must be daisychained, and network expanders used where appropriate - see Appendix A. Refer to Mark Mercer network instructions. The connections are shown in Fig. 5.

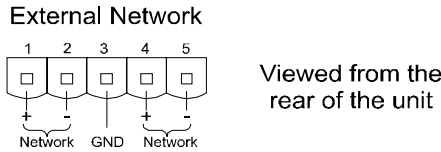

Fig. 5 Mark Mercer network connection

The + and - network lines correspond to the connectors on the receiver shown. Jumpers are provided inside the PY-MMBRD to allow line termination - see Appendix B. Normally, sufficient line termination will already be present on an existing Mark Mercer system.

**PYRAMID NETWORK CONNECTIONS**

The Pyramid network is polarity sensitive therefore connect the network as normal (refer to the Pyramid Network Wiring Instructions). Note that the PY-MMBRD is normally wired in series (daisychained) with other Pyramid nodes on the Pyramid side of the network. If FTT10 is used, free topology may be in use on the Pyramid side of the network.



---

PYRAMID NETWORK CONNECTIONS

---

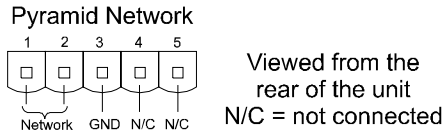

Fig. 7 Pyramid network connection

Note that if a PY.COM card is fitted in the PY-MMBRD it must be set up correctly as instructed in Manual 11 - Pyramid Network Cards.

---

TYPICAL NETWORK CONNECTIONS

---

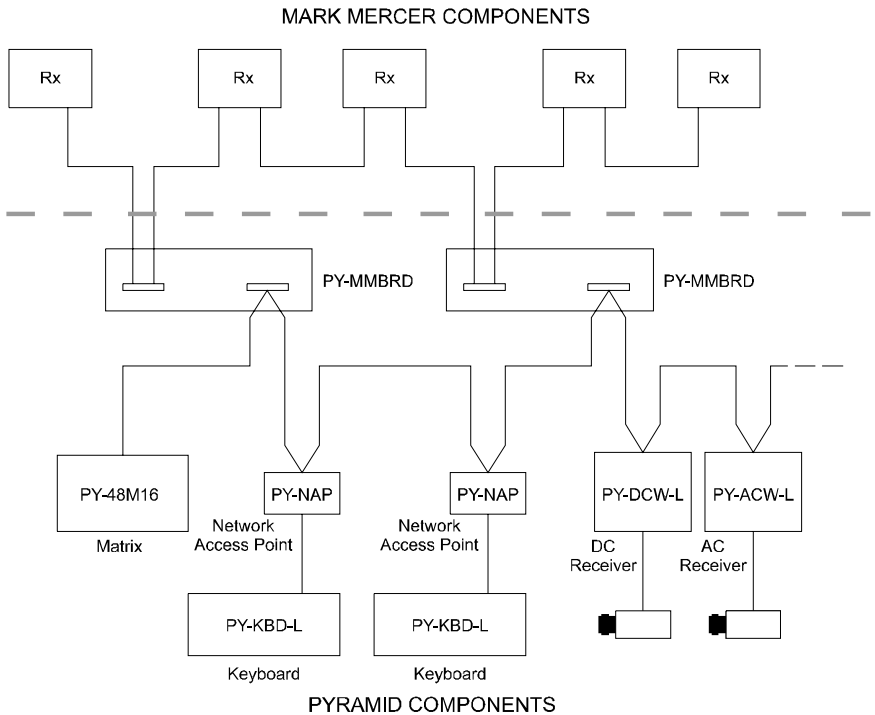

**One PY-MMBRD is required for each keyboard in a control system using multiple keyboards.** Note that the PY-MMBRD can be connected anywhere across the two networks. It does not have to be near the keyboard and in practice would normally be housed in the rack cabinet.

**CONNECTING THE POWER**

**⚠ WARNING**

**Always provide a separate, secure means of isolation**

Your PY-MMBRD has a 115/230V at 47 to 63 Hz auto-line-switching power supply. An IEC connector is provided to connect a mains lead to the power supply shown below.

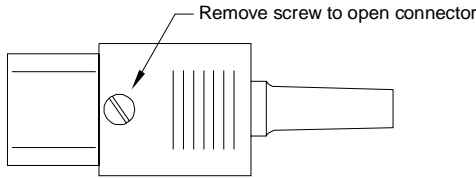

Fig. 8 IEC Connector

To power your PY-MMBRD firstly wire the IEC connector according to the instructions below.

**⚠ WARNING**

**Ensure that all power supplies are off before wiring the IEC connector. Failure to do so may result in electric shock.**

1. Remove the top from the IEC connector by undoing the screw indicated using an appropriate screwdriver.
2. Connect the Neutral (blue) wire to the terminal marked N.
3. Connect the Earth (green and yellow) wire to the terminal labelled E or marked by an earth symbol.
4. Connect the Live (brown) wire to the terminal marked L.
5. Tighten the cord grip.
6. Refit the lid and tighten the screw.
7. Insert the mains connector into the socket on the power supply.

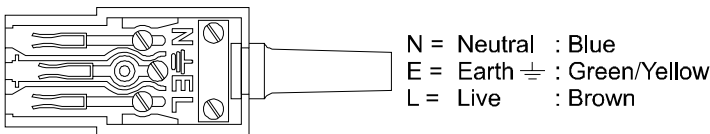

Fig. 9 Internal connections on the IEC plug

**CONNECTING THE 12V DC POWER SUPPLY**

The 12V DC lead has an in-line filter and plugs into the power socket on the rear of your PY-MMBRD electronics.

**SWITCHING ON AND CONFIGURATION**

1. Switch on the power to all your PY-MMBRDs and Mark Mercer receivers. The PY-MMBRDs should display activity on their Rx and Tx LEDs. Press the Service Pin on each PY-MMBRD and they will configure themselves. If the service pin is not pressed, they will take up to 10 minutes to self configure.

*Note: The Pyramid keyboard software must be version 2.11 to operate with a PY-MMBRD.*

2. Select each camera in turn (according to their previous Mark Mercer numbering). Wait for the keyboard LCD to indicate telemetry control. This can take up to 5 seconds for each receiver.

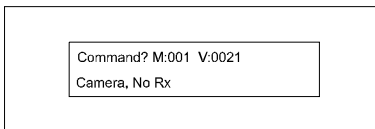

No telemetry control

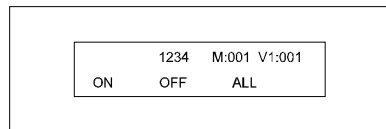

Telemetry control

*Note: If the numbering of the receivers on the Mark Mercer was different from the numbering as attached to the Pyramid matrix, then you can gain telemetry control but cannot view the correct camera.*

The cameras and receivers should now operate as normal. Note that one PY-MMBRD is required for each keyboard in a multiple keyboard control system. If this is the case, then the PY-MMBRDs must be connected in series (daisy-chained) with the other nodes on the Mark Mercer network. If this is not done, then each individual keyboard will only control the part of the network that it is connected to.

**OPERATION USING THE PYRAMID KEYBOARD**

Once telemetry control of each channel is confirmed by the keyboard you then have control of the following receiver functions:

- Pan and Tilt
- Zoom and Focus
- Presets 1 to 16

Select each of these functions in the same way as you would for a Pyramid receiver (see the Operating Instructions).

---

**OPERATION USING THE PYRAMID KEYBOARD**

---

Select each of these functions in the same way as you would for a Pyramid receiver (see the Operating Instructions).

---

**UPDATING YOUR PY-MMBRD SOFTWARE**

---

To load enhancements to your PY-MMBRD as they become available, you can use the Pyramid Utilities tool to send a .NXE file to each PY-MMBRD. The new software file should be sent to every PY-MMBRD in turn because each has its own individual Neuron ID.

*Note : This is not a standard operation and is only intended to be carried out by installation engineers.*

1. Ensure that the PY-MMBRD is powered and connected normally to the Pyramid system network.
2. Start Windows and run the Pyramid Utilities software
3. Click the mouse in the empty Neuron ID box. This will display the Get Neuron ID dialogue box shown in Fig. 10.
4. Press the Neuron ID pin on the PY-MMBRD.
5. The captured Neuron ID for the first PY-MMBRD will now appear in the Neuron ID box. The current software version will also appear in the Software Version box.
6. Select the correct .NXE file and click the Program button in the Utilities dialogue box.
7. Wait until the message 'Programmed Device OK' appears.
8. Capture the Neuron ID for the next PY-MMBRD.

Do this for each PY-MMBRD. Once for each Neuron ID.

---

**SETTING PRESETS**

---

If your presets are already set you do not need to change them. They are stored in the receiver and can still be called by the Pyramid system.

---

**'NO RX' MESSAGE FOR CAMERA WHICH HAS A RECEIVER**

---

Rx is an abbreviation for receiver. You may have 'Receiver present' switched off in the 'Video Source Config' menu. Enter the menu system and change the setting to Bridge.

**Inputs and Outputs**

Pyramid Network  
Mark Mercer Network

---

**Power Supply**

Physical input is a standard IEC connector (provided)  
Physical output 800 mm flying lead to main unit  
Electrical Input : 115/230V AC, 1.2A at 47 to 63 Hz. Automatic line switching  
Electrical Output : 13.5v at max. 2.8A

---

**Physical**

Dimensions  
Assembled unit : 19" x 1U (483 x 44.4) x 116 mm  
Power Supply : 128 x 75 x 43 mm  
Main Unit : 209 x 90 x 40

---

**Temperature Specification**

Operational temperature limits:-  
-10°C to +50°C at 10% to 80% relative humidity (non-condensing)  
Storage temperature limits:-  
-20°C to +60°C at 10% to 95% relative humidity (non-condensing)

**APPENDIX A - PY-MMBRD INTERNAL LINKS**

Internal links within the PY-MMBRD allow line termination and network biasing. Line termination is normally only required where cable runs are in excess of 1000m or in electrically noisy environments.

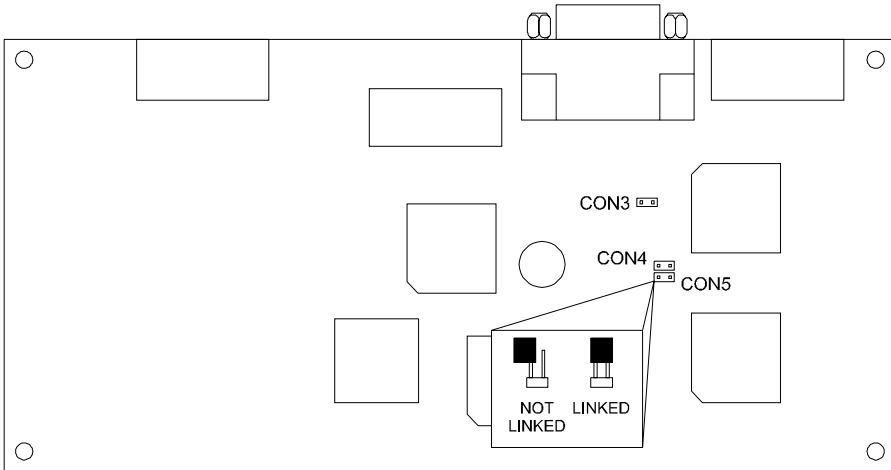

Fig. 12 Location of internal links

|      | Linked           | Not linked          |
|------|------------------|---------------------|
| CON3 | Line Termination | No line termination |
| CON4 | Network biased   | Network not biased  |
| CON5 | Network biased   | Network not biased  |

*Note the PY-MMBRD is supplied by default with the connectors not linked.*



**Baxall Limited**, Stockport, England. Visit our Web site: <http://www.baxall.com>

Baxall Limited reserve the right to make changes to the product and specification of the product without prior notice to the customer.