

Specifications

Basler	A311f	A311fc	A312f	A312fc
<b>Camera</b>				
Resolution	659 x 494	658 x 492	782 x 582	780 x 580
Sensor Type	Sony ICX414AL/AQ, progressive scan CCD		Sony ICX415AL/AQ, progressive scan CCD	
Sensor Optical Size	1/2"		1/2"	
Pixel Size (µm)	9.9 x 9.9		8.3 x 8.3	
Frame Rate at Full Resolution	73 fps		53 fps	
Mono/Color	Mono	Color	Mono	Color
Video Output Type	IEEE1394a		IEEE1394a	
Video Output Format	Mono 8: 8 bits/pixel Mono 16: 12 bits/pixel	YUV 4:2:2: 16 bits/pixel Raw 8: 8 bits/pixel (R,G, or B) Raw 16: 12 bits/pixel (R,G, or B)	Mono 8: 8 bits/pixel Mono 16: 12 bits/pixel	YUV 4:2:2: 16 bits/pixel Raw 8: 8 bits/pixel (R,G, or B) Raw 16: 12 bits/pixel (R,G, or B)
Gain Control	0-22 dB	0-17.4 dB	0-22 dB	0-17.4 dB
Synchronization	Via external trigger, via the 1394 bus, or free run			
Exposure Control	Programmable via the 1394 bus			
<b>Mechanical / Electrical</b>				
Housing Size (L x W x H)	42 mm x 62 mm x 62 mm without lens adapter			
Weight	ca. 210 g			
Power Requirements	8-36 VDC, max. 3.0 W (at 12 VDC), provided via the 1394 cable			
Mount Type	C-mount			
IR-Cut-Filter	optional	standard	optional	standard
Conformity	CE, FCC			
<b>Software and Features</b>				
Camera Features	Long exposure mode, freely programmable area of interest (AOI), trigger ready, look up tables (programmable), lossless compression, and many others included in the Smart Features Framework (SFF)			
Software	BCAM Driver, SDK Package, and SFF			

Specifications are subject to change without prior notice

Dimensions (in mm)

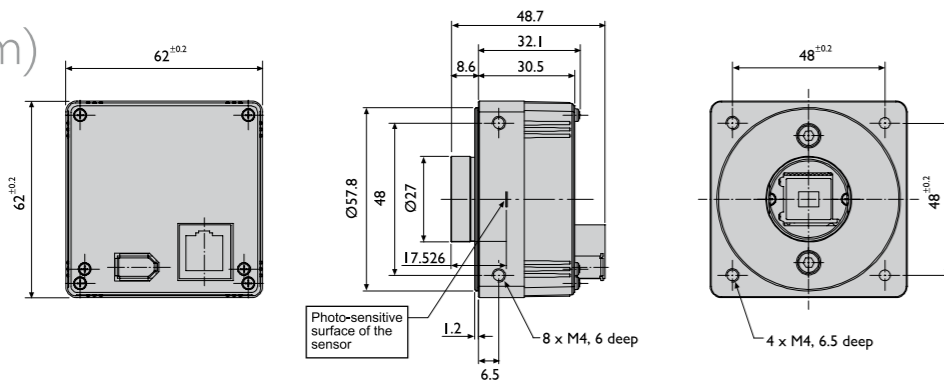

What Makes Basler Camera Quality So Special?



To ensure consistently high product quality, we employ several quality inspection procedures during manufacturing. This list describes some of the most essential actions we take to meet your highest requirements.

- The back focal length on each camera is carefully measured and adjusted. This guarantees an optimum distance between the lens flange and the sensor and ensures compliance with optics standards.
- Our advanced Camera Test Tool (CTT+), the first fully-automated inspection system for digital cameras, checks all of the significant quality aspects of each camera we produce. The CTT+ is a unique combination of optics, hardware, and software that can be quickly and efficiently used to calibrate a camera and to measure its performance against a set of standards. For defined sets of conditions, an automated software program examines the camera's output, makes any calibration adjustments necessary, and compares the output to a strictly defined set of performance criteria.

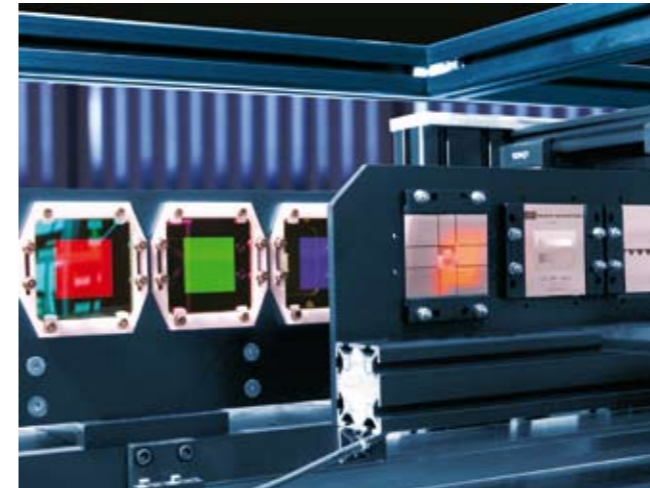

The A300f is measured by the CTT+ according to the EMVA 1288 standard

Basler A300f Series

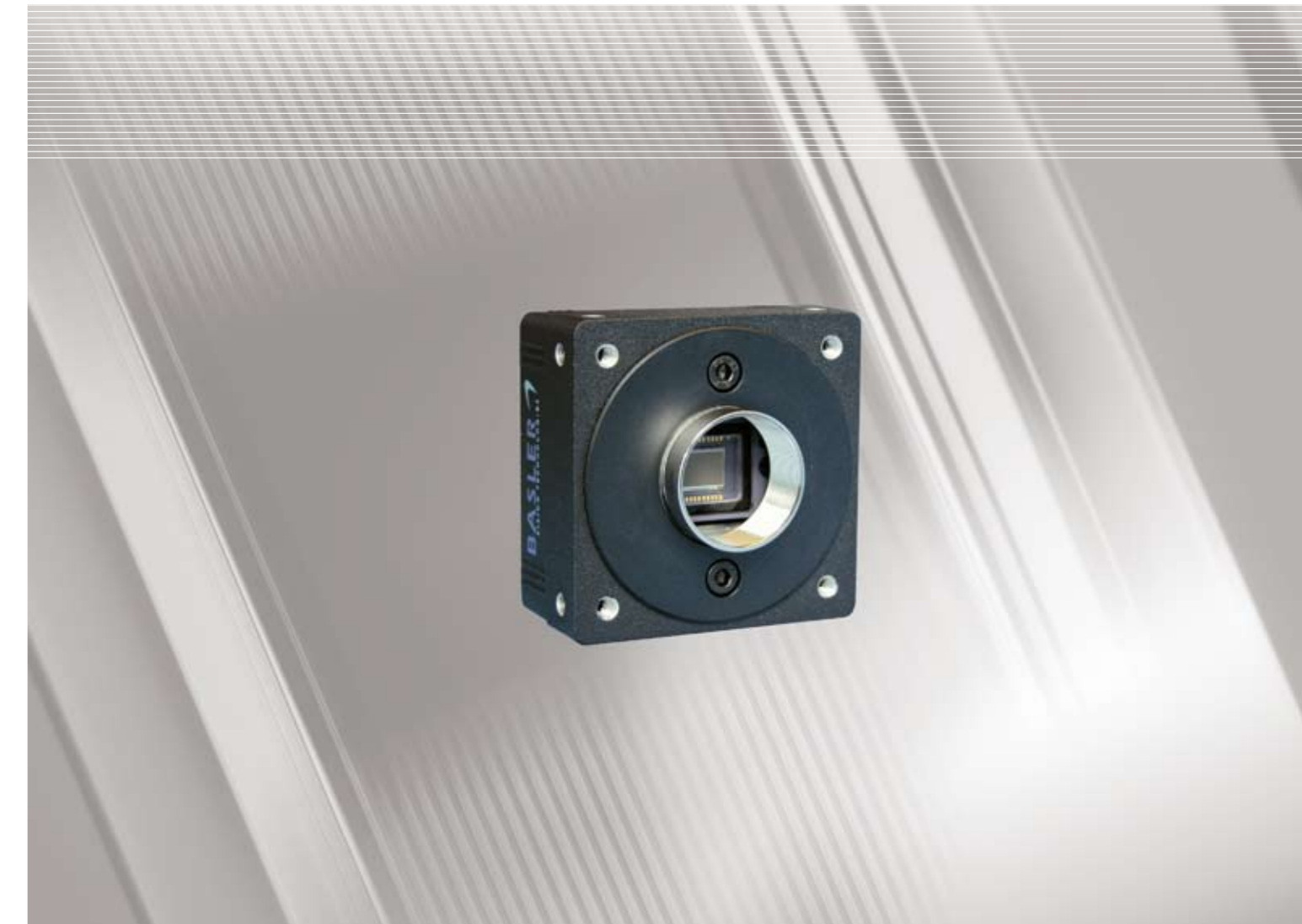

Excellent Image Quality, Small, Easy to Use



www.baslerweb.com

Germany, Headquarters  
Phone +49 4102 463 500  
Fax +49 4102 463 599  
bc.sales.europe@baslerweb.com

USA  
Phone +1 610 280 0171  
Fax +1 610 280 7608  
bc.sales.usa@baslerweb.com

Singapore  
Phone +65 6425 0472  
Fax +65 6425 0473  
bc.sales.asia@baslerweb.com

## A300f Series – Excellent Image Quality at Standard Resolution



FireWire integration is easy, cost-effective, and standardized. It supports plug-and-play and there is no need for a frame grabber.

### One Shot Operation and Software Trigger

The camera lets you use the 1394 bus to “trigger” image capture without the need for a hardware generated signal.

In “one shot” operating mode, the camera normally exposes and transmits a single image based on user defined parameters that are transmitted to the camera. This operating mode usually results in the start of image exposure within an acceptable amount of time. But to get an even quicker response, you can use a “software trigger” to start grabbing a single image exactly when it is needed by your application.

### Trigger Ready

The Trigger Ready feature is a Basler patented innovation. It lets you optimize your image capture timing by monitoring the current camera settings and calculating the earliest moment each exposure can begin.

By using the Trigger Ready signal, you can easily operate at the maximum frame rate allowed with the current camera settings. It also prevents you from running the camera faster than allowed and avoids dropping or losing images.

### Long Exposure Mode

With A300f cameras, an exposure time of up to 5 seconds is possible. This lets you capture superb images even under low light conditions as is often the case in microscopy and medical imaging applications.

### 12 Bit Image Digitization

A300f cameras can digitize each pixel in a captured image at 12 bit depth. This lets you detect even the finest details. In addition, the camera’s remarkably low noise level provides an extraordinary signal-to-noise ratio. Images can be sent at 12 bits via the 1394 bus to a remote computer. You can use the camera’s look up table (LUT) feature to apply “lossless compression” to the image data, which helps you achieve the maximum possible frame rate.

### Color Coding and Preprocessing

A300f color cameras feature various modes of color coding for maximum flexibility in color representation. YUV 4:2:2 color coding is done inside of the camera and YUV image data can be obtained directly via the 1394 bus. For individual processing, each pixel value can be read out separately in raw mode at 8 or 12 bit depth and can be processed as desired in your remote computer.

The A300f series of digital area scan cameras is designed for industrial users who require excellent image quality at either VGA or CCIR resolution. A standard FireWire interface simplifies system integration and gives you increased flexibility when changing cameras.

### Your benefits from the Basler A300f Series include:

- A small, rugged housing for easy integration
- A plug and play FireWire interface combined with the easy-to-use Basler BCAM driver saves you time
- Free download of our BCAM viewer
- 100% quality checked and calibrated to give you consistent performance and reliability

With their flexible design, A300f Series high-performance cameras are a perfect fit for a wide range of vision applications.

### High Framerate and CCD Image Quality

The A300f series combines the high image quality of Sony progressive scan CCD sensors with fast frame readout. At VGA resolution the A311f/1c achieves up to 73 fps. Basler’s design makes this camera appropriate for applications such as semiconductor and component inspection, manufacturing quality control, food and beverage inspection, microscopy and medical imaging, and many others.

### The FireWire Advantage

FireWire, also known as IEEE 1394, has become a standard image data and camera command transmission mechanism in the machine vision industry. Its key benefit is real-time communication between your camera and remote computer at 400 Mbit/s (with FireWire-a).

## Basler Camera Software

### BCAM Driver and SDK Package

When combined with an A300f camera, the BCAM driver offers our users a robust, plug-and-play solution with exceptional performance. Integration is easy and problems with matching cables and creating interface files are eliminated. The driver has been extensively tested with a variety of 1394 interface boards to offer you a new level of reliability. The BCAM SDK package provides easy-to-use low level and high level C++ APIs on top of the driver. The APIs provide access to your camera’s full functionality (e.g., grabbing images and configuring the camera) with Visual Studio and Visual Studio.NET. In addition, the SDK package offers DirectX support via a DirectShow Video Source filter and includes DirectX source code samples for both Visual C++ and Visual Basic.

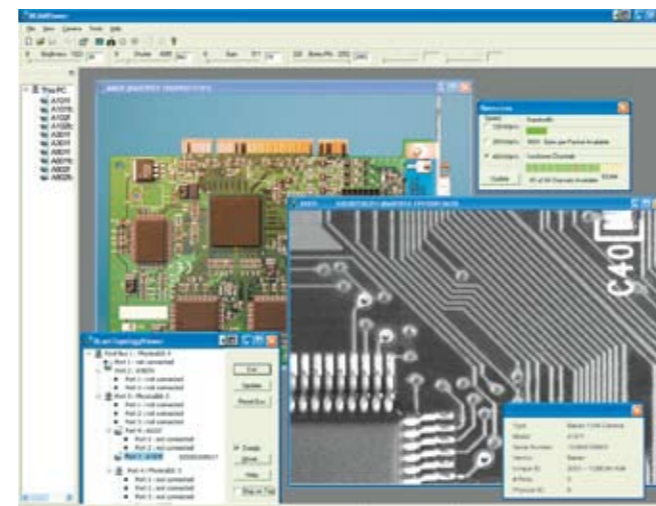

The SDK’s API is fully documented and comes with complete source code for the user mode driver. A collection of code samples demonstrates and explains how to use the SDK. The SDK package also includes some helpful tools (along with the source code for each tool) such as:

- **The BCAM Viewer - an integrated camera viewer program for grabbing images and for configuring the camera**
- **The BCAM Topology Viewer (for Windows XP only) - a bus topology viewer program that lets you quickly evaluate the state of the 1394 bus and the availability of bus resources**

### Smart Features Framework (SFF)

When used with the BCAM Driver, the Smart Features Framework provides access to the smart features included on Basler IEEE 1394 cameras. Basler’s smart features extend the standard IIDC feature set and offer capabilities like:

- **An Extended Data Stream that adds information about the current camera settings – such as shutter, AOI, offset, etc. – to the basic image data for each captured image**
- **A CRC Checksum for the image data**
- **A Frame Counter and Time Stamp for each captured image**
- **Uploading of a Lookup Table to the camera**
- **Lossless Compression of image data**
- **Digital I/O Configuration**

A GUI called the “SFF Viewer/Configurator” is included with the Smart Features Framework. The GUI is used to configure your camera’s smart features and for grabbing images. The SFF also includes a C API along with some sample applications that explain and demonstrate the use of the API.

## Third Party Image Libraries and Software

All Basler 1394 cameras are compliant with the 1394 Trade Association’s DCAM standard. DCAM defines standardized methods for exchanging data and commands between 1394 cameras and computers. All image libraries and software packages compliant with DCAM will work with Basler 1394 cameras. The integration of an A300f camera with DCAM compliant software is as easy as can be.

A selection of companies offering third party products is shown below. Many other products are also available.

- Cognex
- Matrox Imaging
- National Instruments
- Stemmer
- Euresys
- MV Tec
- Neurocheck

## How Does Basler Measure and Define Image Quality?



Basler Components is leading the effort to standardize image quality and sensitivity measurement for machine vision cameras and sensors. All measurements done by Basler will be in 100% compliance with the new European Machine Vision Association EMVA 1288 standard. Because it describes a unified method to measure, compute, and

present the specification parameters for cameras and image sensors used in machine vision applications, Basler is giving the EMVA 1288 standard our strongest support. In the future, we will routinely provide compliant information about the quality and sensitivity of our products.

The following charts and parameters are extracted from standardized quality and measurement processes used by the CTT+.

## Quantum Efficiency

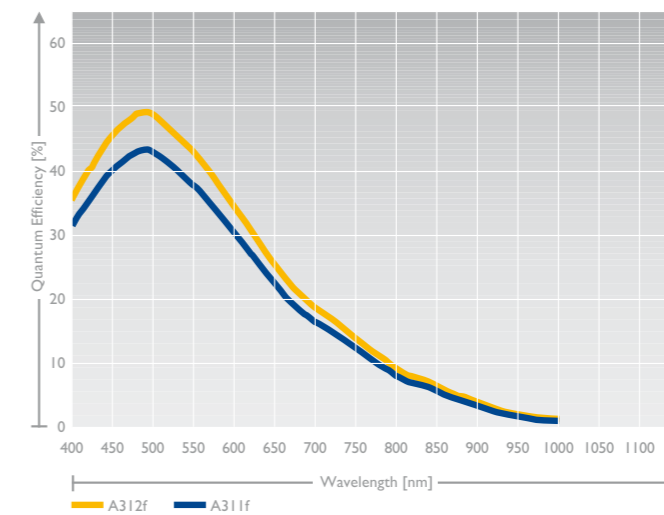

## Sensitivity Parameters\*

Sensitivity Parameters	A311f	A312f
Quantum efficiency @ 545nm (%)	38	43
Dark noise (e-)	23	23
Saturation capacity (e-)	20000	21000
Maximum signal-to-noise ratio (bits) (dB)	7.1 43.0	7.2 43.2
Absolute sensitivity @ 545 nm (photons)	61	54
Photo saturation capacity @ 545 nm (photons)	53000	49000
Dynamic range (bit) (dB)	9.8 58.8	9.8 59.2

## Signal-to-Noise Ratio (dB)\*

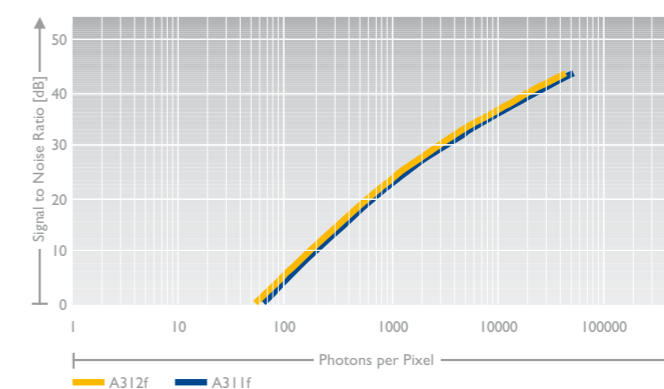

## Signal-to-Noise Ratio (bits)\*

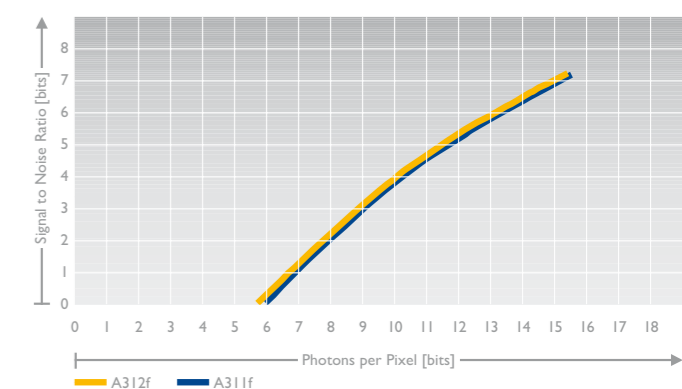

\* All values are typical and are subject to change without prior notice