

1.0 Megapixel Day/Night H.264 HD 4.7-84.6mm Camera

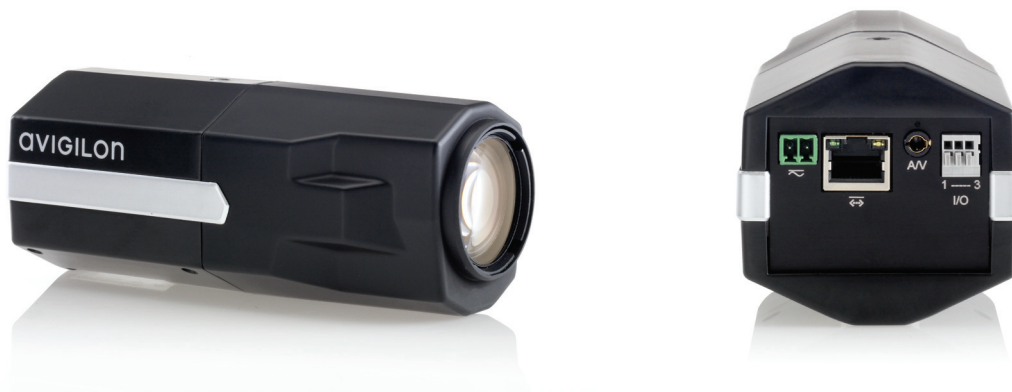

Avigilon's end-to-end surveillance solutions deliver image detail no other system can match. Avigilon Control Center software, featuring High-Definition Stream Management™ (HDSM™) technology combined with our broad range of megapixel cameras (from 1 MP to 29 MP) provide unprecedented clarity—while effectively managing storage and bandwidth requirements. Our components are scalable and can work together in an end-to-end system, or can be customized to create your own powerful and cost-effective solution.

The innovative HD H.264 camera is just one way Avigilon can help provide the very best monitoring and protection.



The 1.0MP H.264 HD camera features an integrated lens for remote focus and zoom control, and is ONVIF compliant for no-hassle integration. It operates on Avigilon's H3 platform, providing this model with improved low light performance and enhanced HDSM features. This camera is extremely versatile and can work in almost any location, including banks, schools, retail outlets, municipal grounds and buildings, hotels, bars and restaurants.

KEY FEATURES

- 1.0 megapixel progressive scan CMOS sensor
- Unsurpassed image quality
- 4.7-84.6mm, F1.6 lens with remote focus and zoom
- 30 images per second at full resolution
- 69dB true dynamic range
- 0.4 lux minimum illumination in color mode and 0.04 lux minimum illumination in monochrome mode
- H.264 and Motion JPEG compression
- ONVIF compliant API
- Multiple video streams
- Automatic exposure control and iris control
- Automatic removable IR cut filter for IR sensitivity at night
- Power over Ethernet, 24 VAC or 12 VDC power input
- Audio Input and Output
- Analog Video Output
- External I/O

Specifications

CAMERA	
Image Sensor	1/3" progressive scan CMOS
Active Pixels	1280 (H) x 720 (V)
Imaging Area	4.2 mm (H) x 2.4 mm (V) (0.165" (H) x 0.094" (V))
Minimum Illumination	0.4 lux (F1.6) in color mode; 0.04 lux (F1.6) in monochrome mode
Dynamic Range	69 dB
Lens	4.7-84.6 mm, F1.6, auto-Iris, remote focus and zoom
Angle of View	3° - 52°
Image Compression Method	H.264 (MPEG-4 Part 10/AVC), Motion JPEG
Image Rate	30 (all resolutions)
Streaming	Multi-stream H.264 and Motion JPEG
Resolution Scaling	Down to 768 x 432
Motion Detection	Selectable sensitivity and threshold
Electronic Shutter Control	Automatic, Manual (1/6 to 1/8000 sec)
Iris Control	Automatic, Manual
Day/Night Control	Automatic, Manual
Flicker Control	50 Hz, 60 Hz
White Balance	Automatic, Manual
Privacy Zones	Up to 4 zones
Audio Compression Method	G.711 PCM 8 kHz
Audio Input	Line input, A/V mini-jack (3.5 mm)
Audio Output	Line level, A/V mini-jack (3.5mm)
Video Output	NTSC/PAL, A/V mini-jack (3.5 mm)
External I/O Terminals	Alarm In, Alarm Out

NETWORK	
Network	100BASE-TX
Cabling Type	CAT5
Connector	RJ-45
API	ONVIF compliant (www.onvif.org)
Security	Password protection, HTTPS encryption, digest authentication, WS authentication, user access log.
Protocol	IPv4, HTTP, HTTPS, SOAP, DNS, NTP, RTSP, RTCP, RTP, TCP, UDP, IGMP, ICMP, DHCP, Zeroconf, ARP
Streaming Protocols	RTP/UDP, RTP/UDP multicast, RTP/RTSP/TCP, RTP/RTSP/HTTP/TCP, RTP/RTSP/HTTPS/TCP, HTTP

MECHANICAL	
Dimensions (LxWxH)	156 mm x 69 mm x 64 mm (6.1" x 2.7" x 2.5")
Weight	0.56 kg (1.2 lbs)
Camera Mount	1/4" UNC-20 (top and bottom)

ELECTRICAL	
Power Source	VDC: 12 V VAC: 24 V PoE: IEEE802.3af Class 3 compliant
Power Consumption	6 W
Power Connector	2-pin terminal block

ENVIRONMENTAL	
Operating Temperature	-10 °C to +50 °C (14 °F to 122 °F)
Storage Temperature	-10 °C to +70 °C (14 °F to 158 °F)
Humidity	20 - 80% Relative humidity (non-condensing)

CERTIFICATIONS		
Safety	UL 60950 CSA 60950 EN 60950-1	CE ROHS WEEE
Electromagnetic Emissions	FCC Part 15 Subpart B Class B IC ICES-003 Class B EN 55022 Class B	
Electromagnetic Immunity	EN 55024 EN 61000-4-2 EN 61000-4-3 EN 61000-4-4	EN 61000-4-5 EN 61000-4-6 EN 61000-4-11

ORDERING INFORMATION	
1.0-H3-B1	1.0 Megapixel Day/Night H.264 HD 4.7-84.6mm Camera

Outline Dimensions

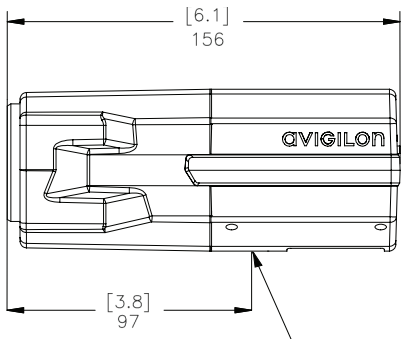
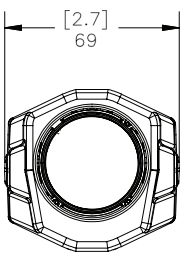

MOUNTING POINT
1/4"-20 UNC
(TOP AND BOTTOM)

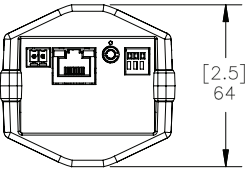

[X.X]	INCHES
X	MM