

## DISCREET CAMERA

## MONOCHROME

# CM-300VR/A

- Indoor vandal-resistant monochrome corner-mount camera

View from below

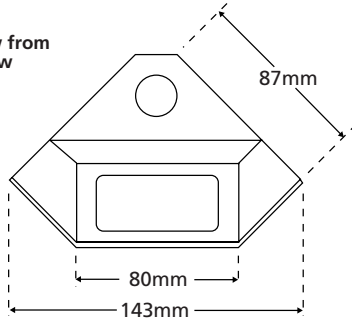



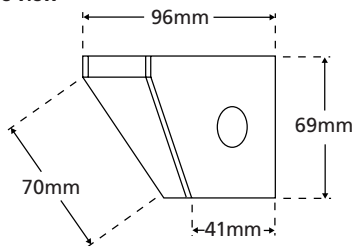

Side view



69mm (H) x 143mm (W) x 96.5mm (D) 600g



-  1/3" CCD
-  380 TV lines
-  0.3 lux sensitivity
-  Supply voltage: 12 Vdc
-  Audio output: 1V p-p

### Lens options

Lens	Product Code
4.0mm	CM-300VR/A
2.5mm	CM-300VR/A/2.5
6.0mm	CM-300VR/A/6.0
8.0mm	CM-300VR/A/8.0
12.0mm	CM-300VR/A/12.0

All lens options are the same price

- Superb picture quality
- White, powder-coated, 1.2mm steel housing
- Easily replaceable, toughened 4mm thick polycarbonate viewing window
- Smoked viewing window also available - product code: VR-WGR
- Tamper-proof upgrade kit available - product code: VR-TRK
- Camera module mounted on manually adjustable miniature 'swivel and tilt' cradle, for exact camera positioning
- Cables feed directly into wall or ceiling so cannot be tampered with
- Comes with free power supply unit

*"These units are small, can withstand a very high level of abuse and we would recommend their use"*

PSI Magazine Bench Test - October 1998

### See Also:



CM-500VR/A  
High resolution option



CC-300VR/A  
Cornice mount option



CM-310VR  
Outdoor option

### VIDEO

SPECIFICATION	MOD-308/A camera module
Image sensor	1/3" CCD sensor, 512 (H) x 582 (V) pixels
Horizontal resolution	380 TV lines or greater
Lens options	SEE TABLE
Electronic shutter	Automatic linear shutter
Sensitivity	0.3 lux
Video output	CCIR, 1Vp-p, 75 Ohms
Supply voltage	12 Vdc ± 10%
Working temperature	-18°C to +60°C

### AUDIO

Microphone	Omni-directional electret
Audio output	1Vp-p, 600 Ohms
Audio bandwidth	100Hz - 10KHz, +/- 3dB