

# pull handles

## Impressionist 03 Series

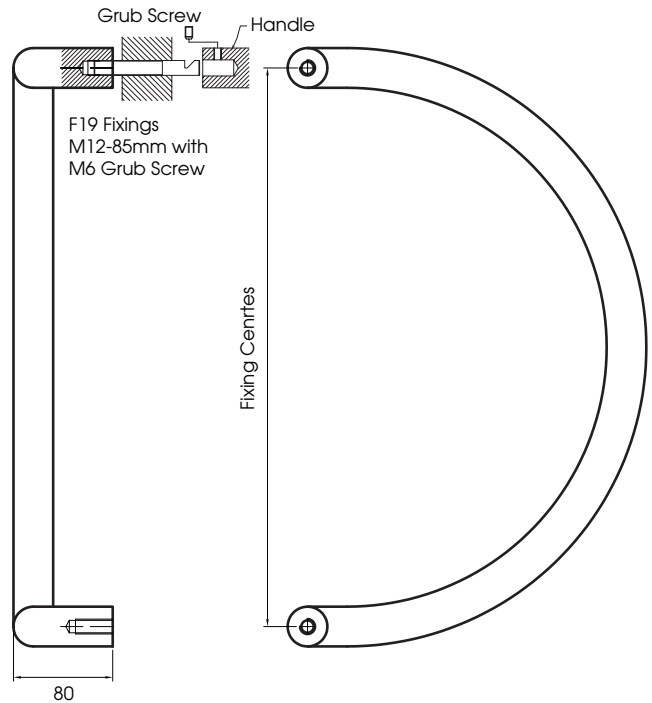
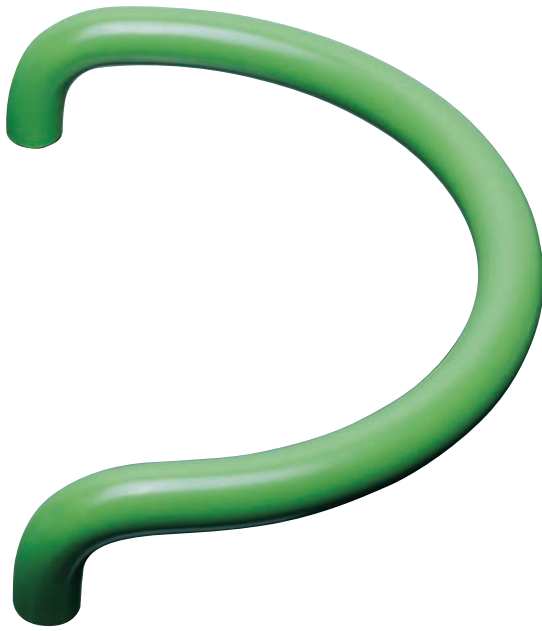

All dimensions shown are in millimetres

Series	Diameter Ø	Centres	Projection	Throw	Overrun	Finishes Available	Code
Imp 03	32	250	80	N/A	N/A	Satin Anodised	SAA
Imp 03	38	350	80	N/A	N/A	Satin Stainless	SSS
						Polished Stainless	PSS
						Powder Coated	PC
						Nylon Coated	NC

### Ordering Guide - please specify the following details:

Series	Ø	Size	Fixing Kit	Finish	Door Type
Imp 03	32	250	F19	SSS	Aluminium

#### Notes

Handles are supplied with bolt-thru or back to back fixing as standard.

Fixing kit information can be found at the back of this catalogue. Stainless steel handles are manufactured from 304 grade stainless steel.

Powder coated and Nylon coated handle colours are not ex-stock colours. Additional lead times should be allowed for these items and may be subject to a paint surcharge.

#### Colour options

**For Powder coated and Nylon coated handles please contact our Sales Team on 01202 676262 for price and availability.**

# pull handles

## Fixing information

All Alpro handles are supplied with their own dedicated fixing packs, which suit all the possible door materials available. Full fixing and maintenance instructions are included in the handle kits, to ensure the correct methodology is employed when fixing the handles. In the event of the fixing kits being mislaid or broken, replacement kits are available by contacting the Alpro sales office on 01202 676262 and specifying the necessary requirements.

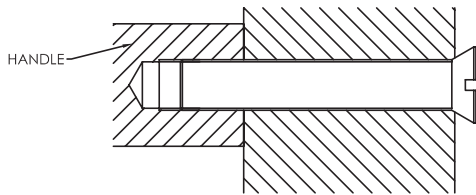

### F17

39-54mm thick doors

For 32mm Ø Impressionist handles

For 25, 32 & 38mm Ø Functional 98 series handles

M12-70mm countersunk

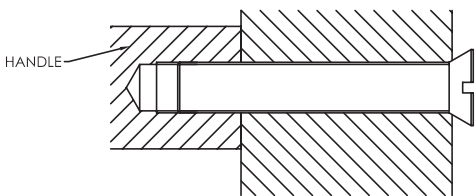

### F18

55-85mm thick doors

or 32mm Ø Impressionist handles

For 25, 32 & 38mm Ø Functional 98 series handles

M12-95mm countersunk

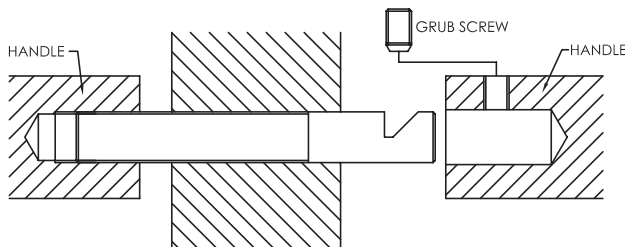

### F19

39-54mm thick doors

or 32mm Ø Impressionist handles

For 25, 32 & 38mm Ø Functional 98 series handles

M12-85mm with M6 grub screw

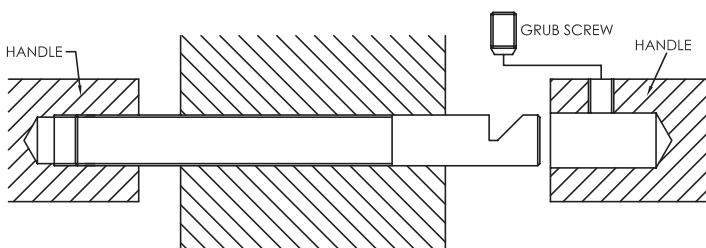

### F20

55-85mm thick doors

or 32mm Ø Impressionist handles

For 25, 32 & 38mm Ø Functional 98 series handles

M12-110mm with M6 grub screw

# pull handles

## Fixing information

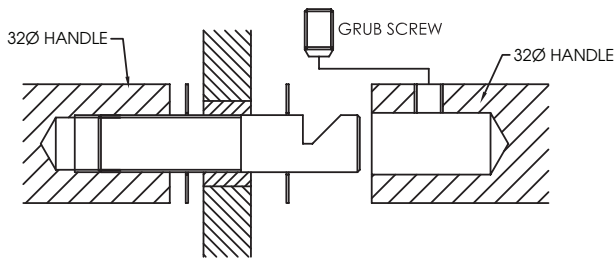

### F21

Glass doors  
For 32mm Ø Impressionist handles  
For 25, 32 & 38mm Ø Functional 98 series handles  
M12-55mm with M6 grub screw

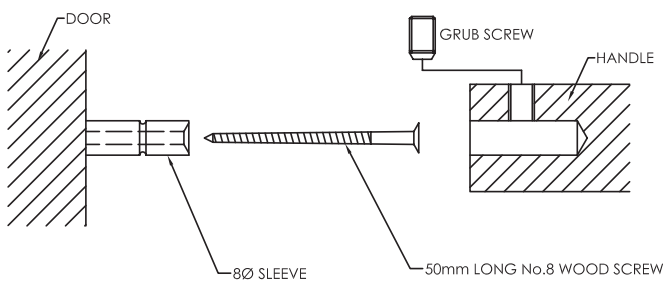

### F22 Secret fixing

For fixing to a wooden door 25mm deep  
For 32mm Ø Impressionist handles  
NB - Use these fixings for timber doors only  
(This fixing is not recommended on Aluminium doors)

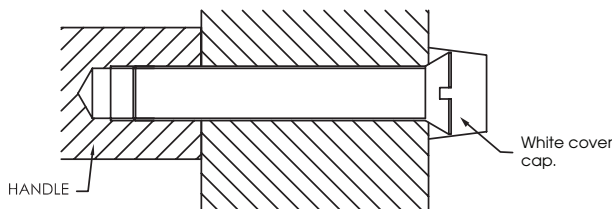

### F26

39-54mm thick doors  
For 32mm Ø Impressionist handles  
For 25, 32 & 38mm Ø Functional 98 series handles  
M12-70mm countersunk with dome cap  
NB - Cover cap is available in black on request

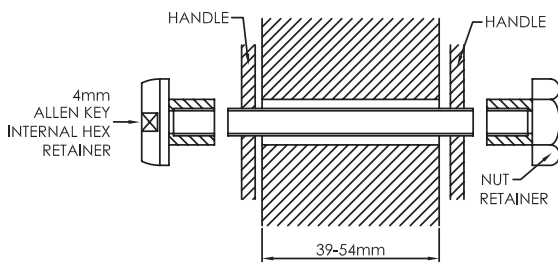

### F27

6.5mm Ø clearance hole required  
For Functional 97 Series handles

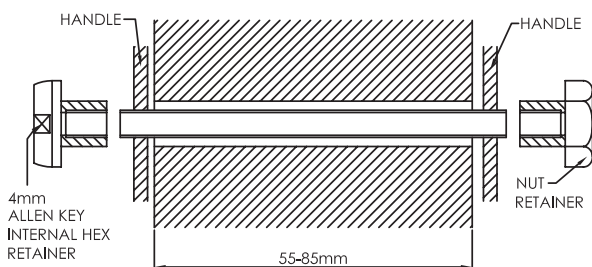

### F28

6.5mm Ø clearance hole required  
For Functional 97 Series handles

# pull handles

## Fixing information

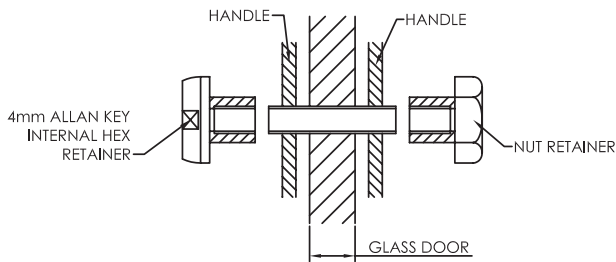

### F29

6.5mm Ø clearance hole required  
For Functional 97 Series handles

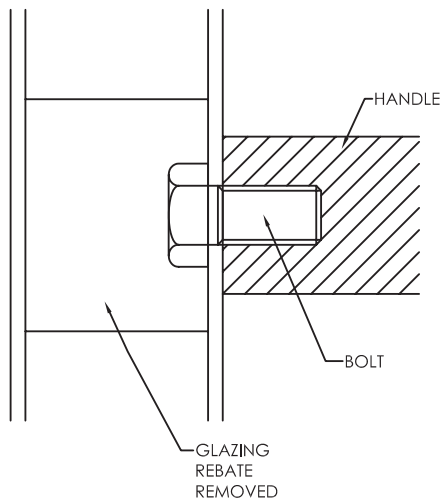

### F34

M12 fixings  
For 32mm Ø Impressionist handles  
For 25, 32 & 38mm Ø Functional 98 series handles  
M12 x 25mm long hexagon headed bolt grade 8.8.

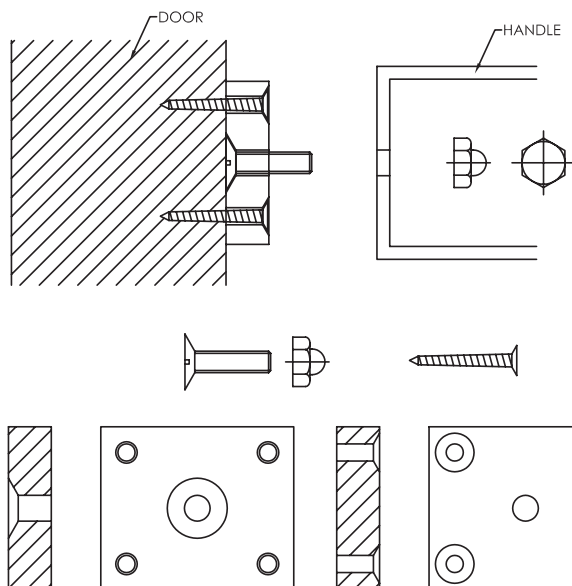

### F38

For Functional 97 Series handles only  
M6 x 20mm long countersunk bolt and 4 off No. 8 x 25 long wood screws

#### HOLE SIZES FOR FIXING THROUGH:

For M12 fixing - Wood & Aluminium = 13mm Ø  
For M12 fixing - Glass = 18mm Ø