

pull handles

Impressionist 02 series

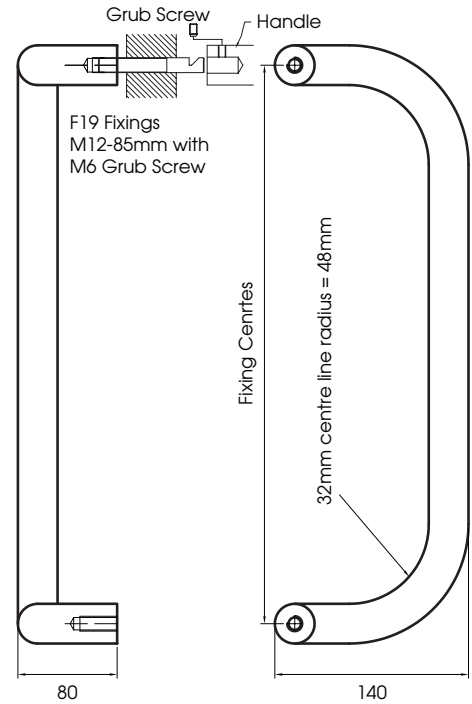
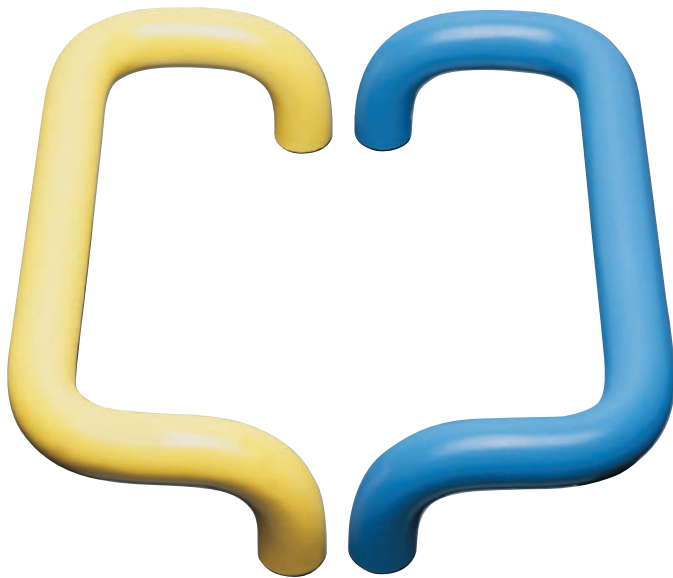

All dimensions shown are in millimetres

Series	Diameter Ø	Centres	Projection	Throw	Overrun	Finishes Available	Code
Imp 02	32	250 / 300 / 400 / 600	80	140	N/A	Satin Anodised	SAA
						Satin Stainless	SSS
						Polished Stainless	PSS
						Powder Coated	PC
						Nylon Coated	NC

Ordering Guide - please specify the following details:

Series	Ø	Size	Fixing Kit	Finish	Door Type
Imp 02	32	300	F19	SSS	Aluminium

Notes

Handles are supplied with bolt-thru or back to back fixing as standard.

Fixing kit information can be found at the back of this catalogue. Stainless steel handles are manufactured from 304 grade stainless steel.

The following Nylon coated colours are available ex stock:

Black	(RAL9005)
White	(RAL9010)
Ultra Marine Blue	(RAL5002)
White Aluminium	(RAL9006)
Agate Grey	(RAL7038)

Additional colours are available at extra cost with a 10 working day lead time.

If the finish you require is not shown please contact us.

pull handles

Fixing information

All Alpro handles are supplied with their own dedicated fixing packs, which suit all the possible door materials available. Full fixing and maintenance instructions are included in the handle kits, to ensure the correct methodology is employed when fixing the handles. In the event of the fixing kits being mislaid or broken, replacement kits are available by contacting the Alpro sales office on 01202 676262 and specifying the necessary requirements.

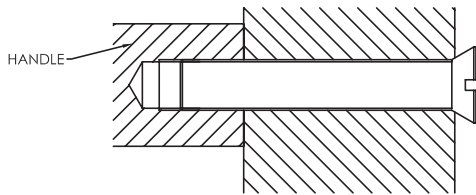

F17

39-54mm thick doors

For 32mm Ø Impressionist handles

For 25, 32 & 38mm Ø Functional 98 series handles

M12-70mm countersunk

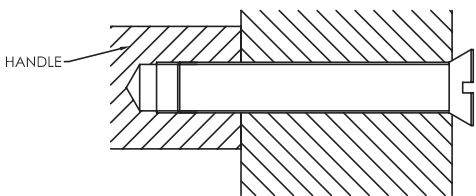

F18

55-85mm thick doors

or 32mm Ø Impressionist handles

For 25, 32 & 38mm Ø Functional 98 series handles

M12-95mm countersunk

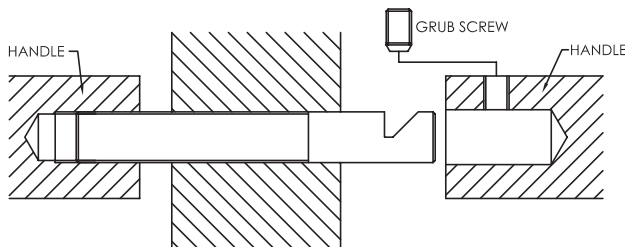

F19

39-54mm thick doors

or 32mm Ø Impressionist handles

For 25, 32 & 38mm Ø Functional 98 series handles

M12-85mm with M6 grub screw

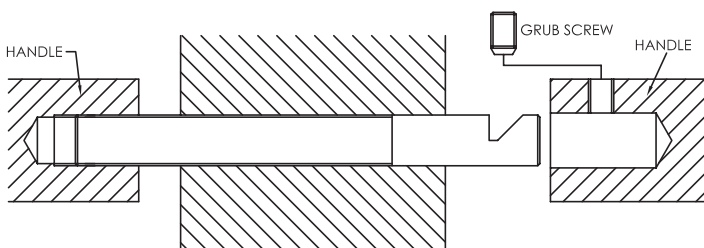

F20

55-85mm thick doors

or 32mm Ø Impressionist handles

For 25, 32 & 38mm Ø Functional 98 series handles

M12-110mm with M6 grub screw

pull handles

Fixing information

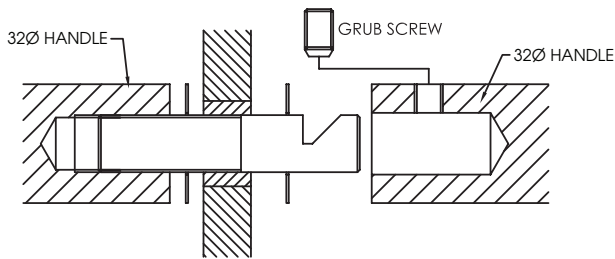

F21

Glass doors
For 32mm Ø Impressionist handles
For 25, 32 & 38mm Ø Functional 98 series handles
M12-55mm with M6 grub screw

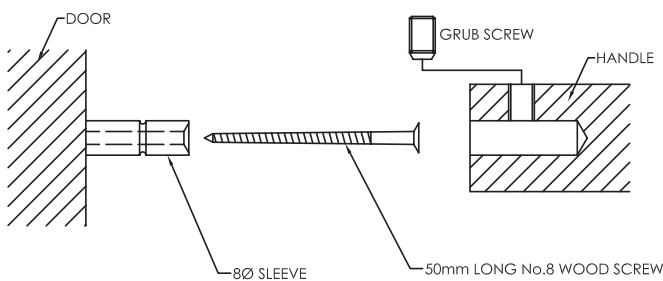

F22 Secret fixing

For fixing to a wooden door 25mm deep
For 32mm Ø Impressionist handles
NB - Use these fixings for timber doors only
(This fixing is not recommended on Aluminium doors)

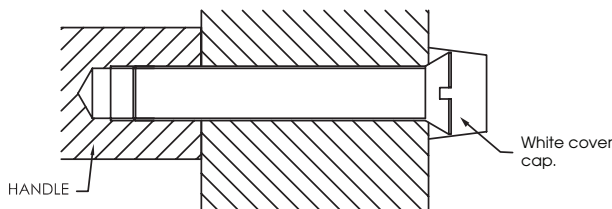

F26

39-54mm thick doors
For 32mm Ø Impressionist handles
For 25, 32 & 38mm Ø Functional 98 series handles
M12-70mm countersunk with dome cap
NB - Cover cap is available in black on request

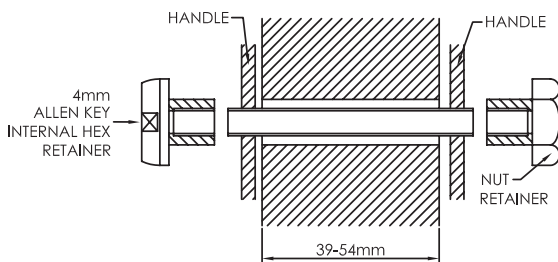

F27

6.5mm Ø clearance hole required
For Functional 97 Series handles

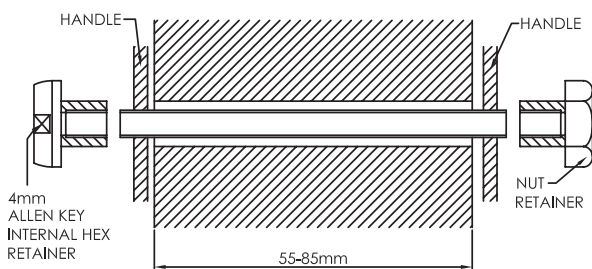

F28

6.5mm Ø clearance hole required
For Functional 97 Series handles

pull handles

Fixing information

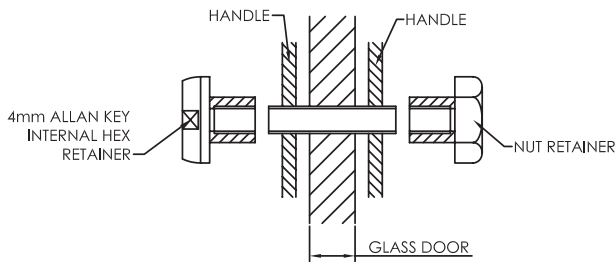

F29

6.5mm Ø clearance hole required
For Functional 97 Series handles

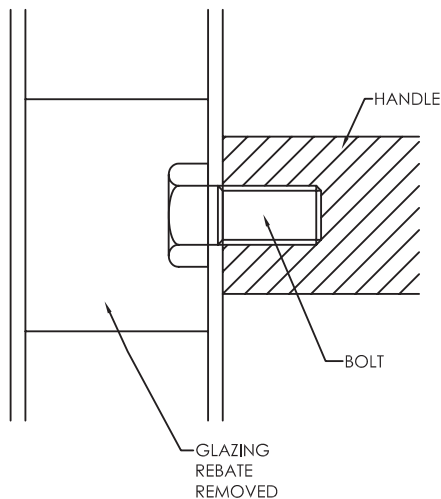

F34

M12 fixings
For 32mm Ø Impressionist handles
For 25, 32 & 38mm Ø Functional 98 series handles
M12 x 25mm long hexagon headed bolt grade 8.8.

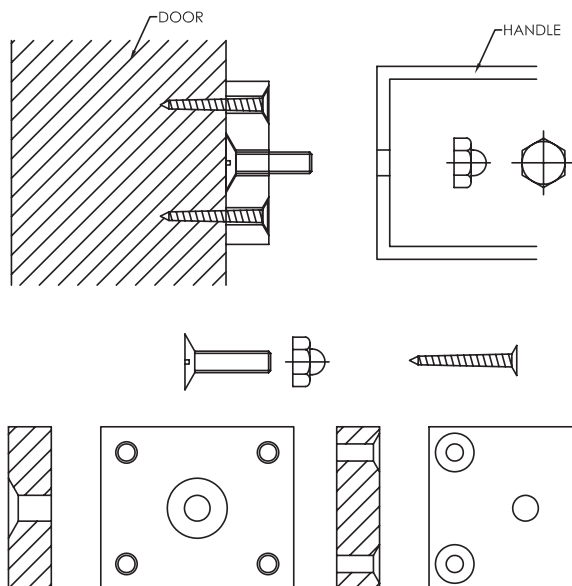

F38

For Functional 97 Series handles only
M6 x 20mm long countersunk bolt and 4 off No. 8 x 25 long wood screws

HOLE SIZES FOR FIXING THROUGH:

For M12 fixing - Wood & Aluminium = 13mm Ø
For M12 fixing - Glass = 18mm Ø