

MK Series PANTILT VIDEO DOOR STATION

Models: **MK-DAC**, *Single-gang surface mount*
MK-DBC, *3-gang semi-flush mount*

INSTALLATION & OPERATION MANUAL

! PRECAUTIONS ON OPERATIONS

This Manual and the Markings on the product contain various symbols in order that the product can be used safely and properly, and that the installer and user are protected from injury and property damage. The following precautions must be thoroughly read and understood before proceeding.

! WARNING *Negligence could result in death or serious injury.*

Explanations of Symbols;



GENERAL PRECAUTIONS

The  mark indicates caution statement (incl. danger and warning), which is specifically shown inside.



GENERAL INSTRUCTIONS

The  mark indicates contents which demands a specific action shown inside or attached.







GENERAL PROHIBITIONS

The  mark indicates contents which prohibit a specific action shown inside or attached.



DISMANTLE PROHIBITIONS

! WARNING

1. When existing chime wires are used, be sure to locate and disconnect the bell transformer. 
Unit damage or electric shock could result. Ask qualified personnel.
2. Do not change or alter MK-DAC/DBC. It can cause fire or electric shock. 
3. Video door station is weather-resistant, but do not spray directly on video door station to prevent electric shock. 
4. Make sure wires are connected properly before plugging in power supply. Fire or electric shock could result. 

1 SYSTEM OUTLINE & COMPONENTES

MK-DAC & MK-DBC are PanTilt camera video door stations for use with Aiphone MY series Video Entry Security Intercoms.

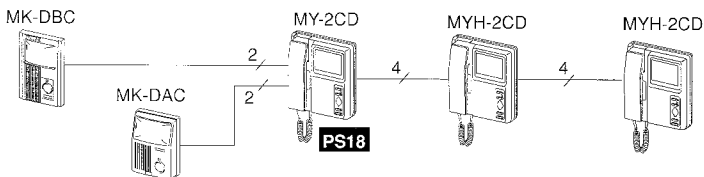

Package Contents

- PanTilt video door station (**MK-DAC or MK-DBC**)
- Packet of screws
- Hexagonal wrench
- Installation & Operation Manual

PS18 : PS-18E
PS-18C

2 NAMES & FEATURES

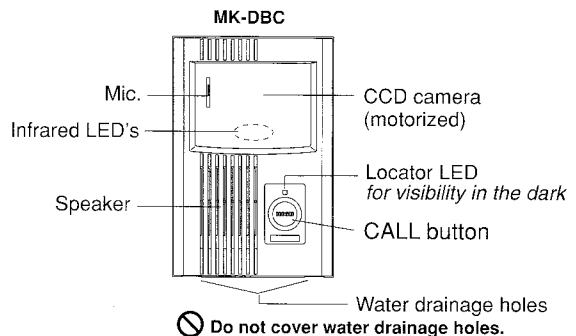
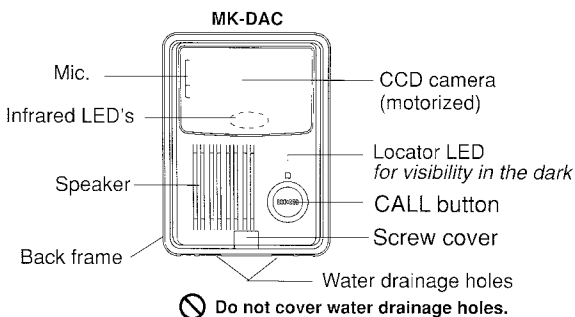

Features Works with MY-1CD, MY-2CD, MY-2C2D, MY-CU monitor w/ IE-8MD or TD-H/B intercom, MYW-P1L/P3L & MYH-CU(B) w/LEF(-C), and TB-ADM10 w/ TB-M.

1. 2-conductor non-polarized wiring
2. Infrared LED's sees in the dark.
3. MK-DAC: single-gang surface mounting or MK-DBC: 3-gang semi-flush mounting (w/polycarbonate cover)

3 INSTALLATION

Wiring precautions

1. Keep video wires more than 30cm/1' away from AC 100~240V power lines.
2. Employ 2-conductor parallel wires only. Coax-cable can not be used.
3. When existing cable is used, install a 120Ω resistor at both ends of unused wires.
4. Do not mix audio/video wires with those of another video door station or device.

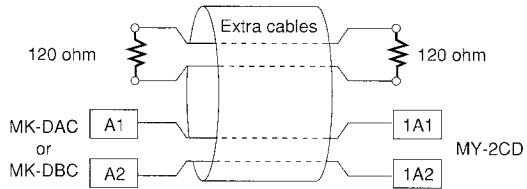
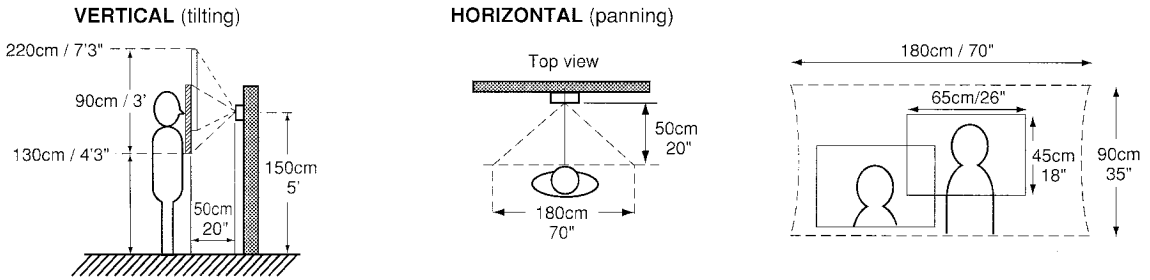

Image view area (approx.) when pan-and-tilted



- The image view area is a guideline, and may vary according to environment.
- The peripheral part of monitor may slightly be distorted.
- The image may have reflective light come into lens from camera cover.

Mounting locations & height

- Install a video door station in the following locations;
- Places subject to temperature/humidity extremes.
 - Places from from dust, vapor, smoke and chemicals.
 - Places where a call is strongly backlit (white wall is on the background).
 - Places where direct sunlight or strong light comes into the camera lens.

Mounting locations

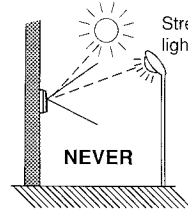
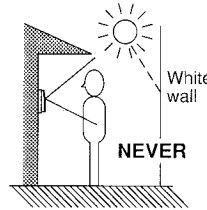

Mounting height

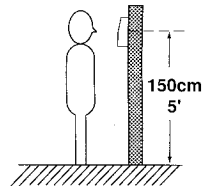

4 WIRING DIAGRAM

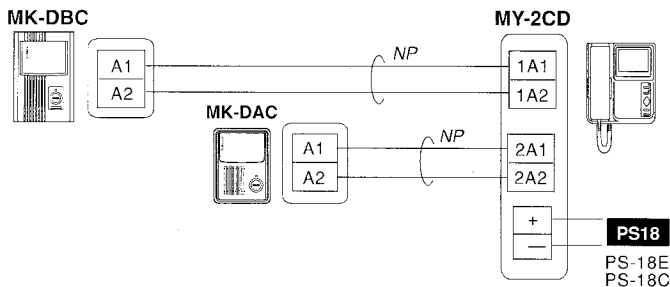

5 MOUNTING

MK-DAC

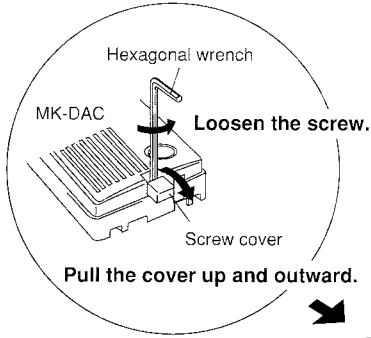

Single-gang surface mounting

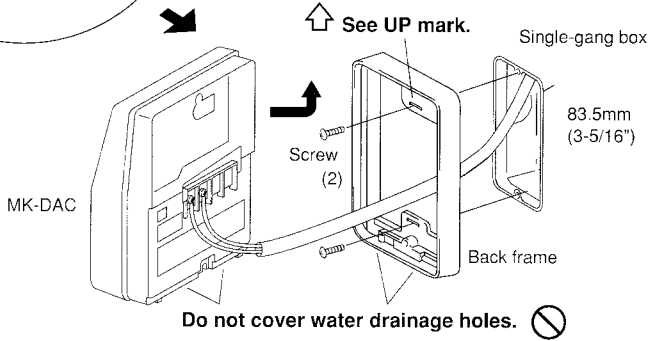

Surface wall mounting

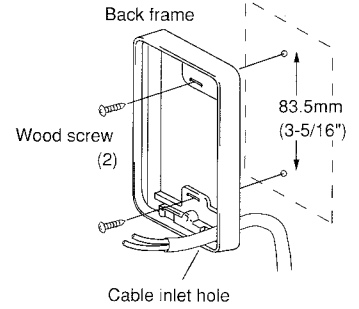

MK-DBC

3-gang semi-flush mounting

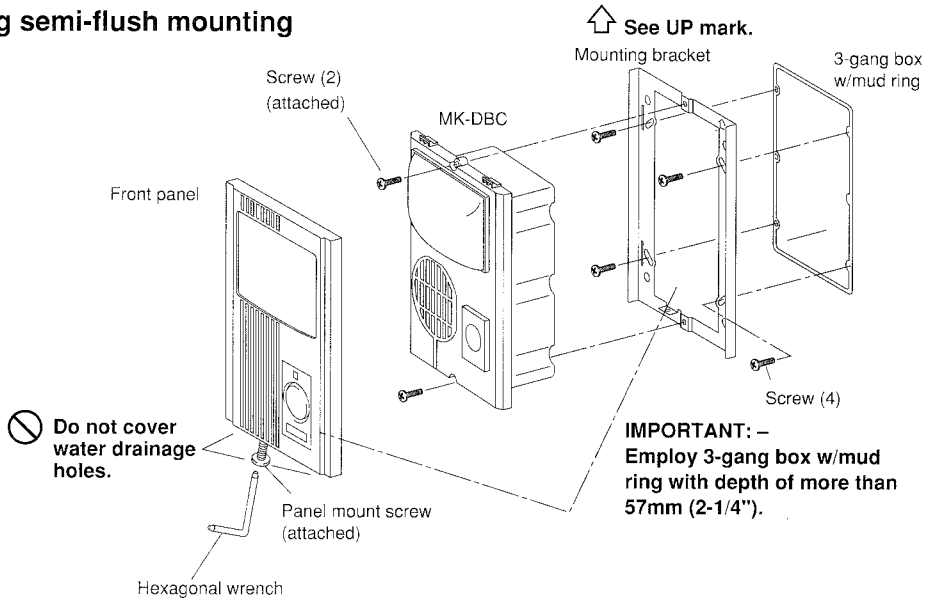

6 OPERATIONS

Calling: – Momentarily press CALL button on door station.
After room station replies, talk handsfree in front of camera.

7 TECHNICAL PRECAUTIONS

Caulking seals: Do not apply any caulking seals around video door station. Water drainage holes on bottom will help water or moisture to dissipate.

Cleaning: Clean MK-DAC/DBC with a soft cloth dampened with neutral household cleanser. Never use any harsh cleaner and cloth. Do not spray high-pressure water on video door station.

8 SPECIFICATIONS

Power source: Supplied by master station.
Consumption: 370mA (max.). 4.5mA (Standby) (approx.)
Picture element: CCD camera.

Image view area (approx.):		Vertical	Horizontal	Vertical	Horizontal
	In horizontal position:	45cm	65cm	18"	26"
	When pan-and-tilted:	90cm	180cm	3'	6'

Min. illumination: Less than 1 Lux (at 50cm / 20" from camera).

Ambient temperature: -10 °C ~ 60 °C (14 °F ~ +140 °F).

Wiring: 2 parallel wires, non-polarized to master.

Wiring distance:	Diameter	0.65mmø	1.0mmø
	DISTANCE	50m	100m
	AWG	22AWG	18AWG
	DISTANCE	165'	330'

Unit housing & color: Fire-retardant plastic in black.

Dimensions: MK-DAC: 98 W x 130 H x 47.5 D (mm).
(3-1/8"W x 5-1/8"H x 1-7/8"D)
MK-DBC: 115 W x 172H x 31.5 D (37 in recess) (mm).
(4-1/2"W x 6-3/4"H x 1-1/4"D) (1-1/2" in recess)

Weight (approx.): MK-DAC: 240g(0.53 lbs.). MK-DBC: 350g(0.77 lbs.).

This equipment has been tested and found to comply with the limits for a Class B digital device, pursuant to Part 15 of the FCC Rules. These limits are designed to provide reasonable protection against harmful interference in a residential installation. This equipment generates, uses, and can radiate radio frequency energy, and if not installed and used in accordance with the instructions, may cause harmful interference to radio communications. However, there is no guarantee that interference will not occur in a particular installation. If this equipment does cause harmful interference to radio or television reception, which can be determined by turning the equipment off and on, the user is encouraged to try to correct the interference by one or more of the following measures:

- Reorient or relocate the receiving antenna.
- Connect the equipment into an outlet on a circuit different from that to which the receiver is connected.
- Increase the separation between the equipment and receiver.
- Consult the dealer or an experienced radio/TV technician for help.

WARRANTY

Aiphone warrants its products to be free from defects of material and workmanship under normal use and service for a period of two years after delivery to the ultimate user and will repair free of charge or replace at no charge, should it become defective upon which examination shall disclose to be defective and under warranty. Aiphone reserves unto itself the sole right to make the final decision whether there is a defect in materials and/or workmanship; and whether or not the product is within the warranty.

This warranty shall not apply to any Aiphone product which has been subject to misuse, neglect, accident, or to use in violation of instructions furnished, nor extended to units which have been repaired or altered outside of the factory. This warranty does not cover batteries or damage caused by batteries used in connection with the unit.

This warranty covers bench repairs only, and any repairs must be made at the shop or place designated in writing by Aiphone. Aiphone will not be responsible for any costs incurred involving on site service calls.

AIPHONE CO., LTD., NAGOYA, JAPAN
AIPHONE CORPORATION, BELLEVUE, WA, USA
AIPHONE EUROPE N.V., ANTWERP, BELGIUM



MK-DAC-I (E) 0200A

Printed in Japan (E)