

IR LED Illuminator



---

**FEATURES**

---

- Compact chassis
- MTBF > 100,000 hours

---

**SPECIFICATIONS**

---

Optical Wavelength	880 nm
Max. IR Distance	270 m
Beam Angle	30°
Protection Rating	IP66
MTBF at 25° C	> 100,000 hours
Supply Voltage	12 VDC / 220 VAC
Including	Bracket & PSU included
Power Consumption	84 W
Weight	4.5 kg
Dimensions w*h*d	236 x 270 x 272 mm

IR LED Illuminator

## DIMENSIONS

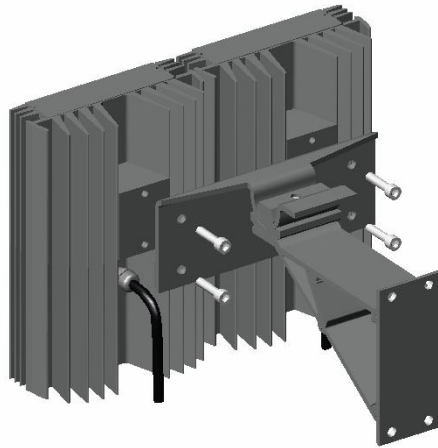

## Angles of view

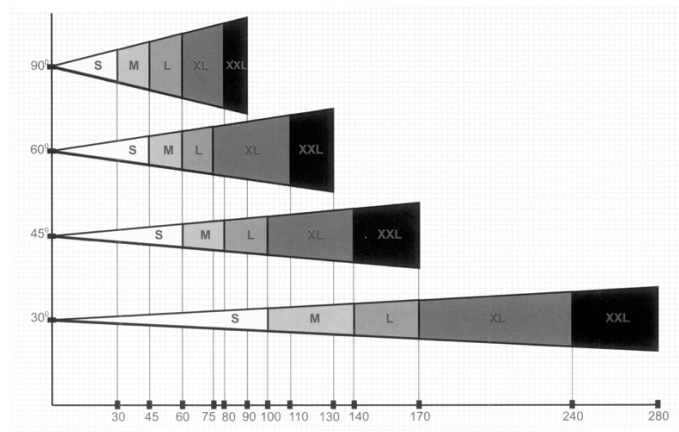

IR LED Illuminator

---

**ACCESSORIES**

---



**AST ST3**  
IR LED Illuminator wall bracket

---

